



Catálogo



CONTENIDO

ARTICULOS PROMOCIONALES



ANTIESTRESS

- PELOTAS LISAS
- PELOTAS SPORT
- FIGURAS ESPECIALES

03



EJECUTIVA

- CARPETAS
- TARIJEROS
- PORTAFOLIOS
- PORTADOCUMENTOS

37



BAR

- HIELERAS
- SETS DE VINO
- SETS DE JUEGO

11



ESCOLARES Y NIÑOS

- ALCANCIAS
- MOCHILAS
- LAPICERAS

53



BELLEZA Y SALUD

- PASTILLEROS
- SETS DE MANICURE
- KITS DE BELLEZA

17



ESCRITURA

- BOLÍGRAFOS
- LAPICEROS
- MARCA TEXTOS

73



ECOLOGICA

- BOLÍGRAFOS
- SETS DE NOTAS
- LIBRETAS

25



HERRAMIENTAS

- NAVAJAS
- FLEXÓMETROS
- LÁMPARAS

111



COCINA Y HOGAR

- SET DE COCINA
- JARRAS
- MANDILES

125



RELOJES

- BAKIO
- INNOVATION
- PARED Y ESCRITORIO
- SETS

205



LIBRETAS

- ESCOLARES
- ECOLOGICAS
- POCKET

131



SPORT

- BINOCULARES
- SETS DE GOLF
- APLAUDIDORES

235



LLAVEROS

- ACERO INOXIDABLE
- DESTAPADOR
- CON LUZ LED

147



TAZAS Y CILINDROS

- TAZAS
- TERMOS
- VASOS

239



MAGENTA PROMOS

- COSMETIQUERAS
- BOLSAS
- BOLÍGRAFOS

161



TECNOLOGÍA

- USB'S
- MULTICONECTORES
- BOCINAS

261



MOCHILAS Y MALETAS

- ESCOLARES
- DEPORTIVAS
- BACK PACK

175



HIELERAS

- TÉRMICAS
- 6 Y 12 PACK
- LUNCH TO GO

273



OFICINA

- RELOJ DE ESCRITORIO
- PORTA NOTAS
- SETS DE ESCRITORIO

187



VIAJE

- TRAVEL BAGS
- CARRY-ON
- PARAGUAS
- SETS DE LUSTRADO

281



ANTIESTRES

SB-01

Antiestrés Basketball

Pelota antiestrés basketball, fabricada en poliuterano.
Impresión: Tampografía.

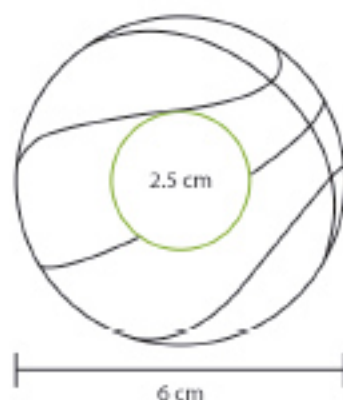

SB-02

Antiestrés Fútbol Americano

Pelota antiestrés fútbol americano, fabricada en poliuterano.
Impresión: Tampografía.

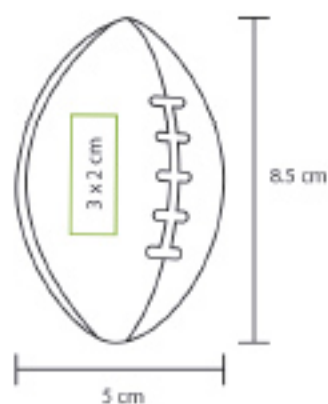

SB-03

Antiestrés Soccer

Pelota antiestrés soccer, fabricada en poliuterano.
Impresión: Tampografía.

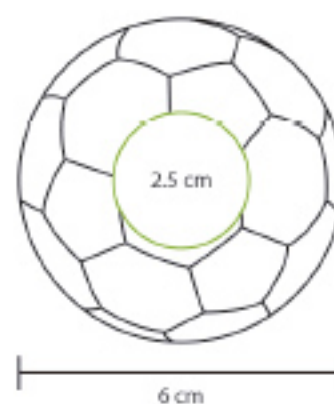

SB-04

Antiestrés Golf

Pelota antiestrés golf, fabricada en poliuterano.
Impresión: Tampografía.

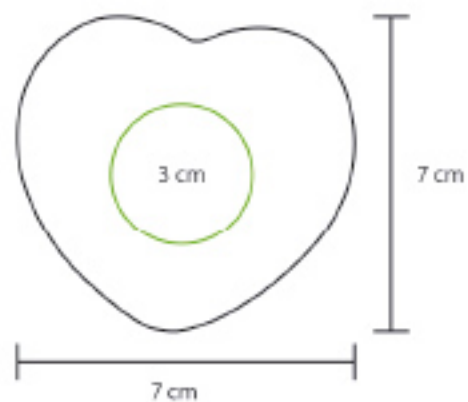
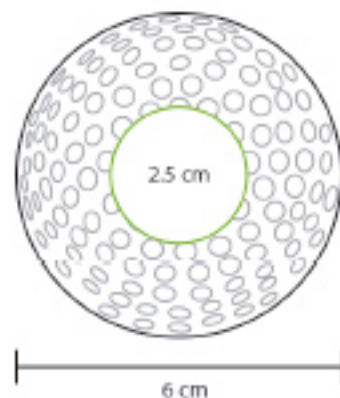

SB-05

Antiestrés Tennis

Pelota antiestrés tennis, fabricada en poliuterano.
Impresión: Tampografía.

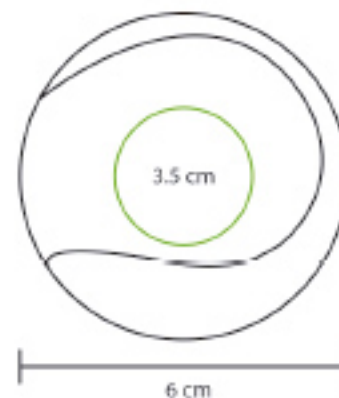

SB-06

Corazón Antiestrés

Figura antiestrés en forma de corazón,
fabricada en poliuterano.
Impresión: Tampografía.

SB-07

Cubo Antiestrés

Figura de cubo antiestrés, fabricada en poliuterano.

Colores: Azul, blanco y rojo.

Impresión: Tampografía.

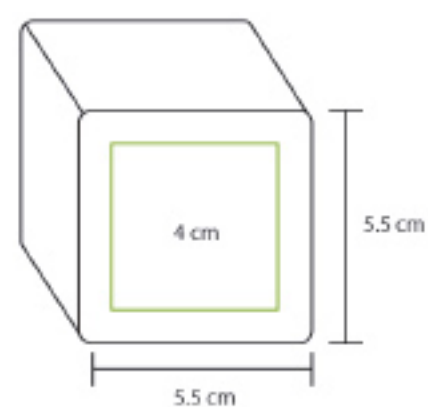
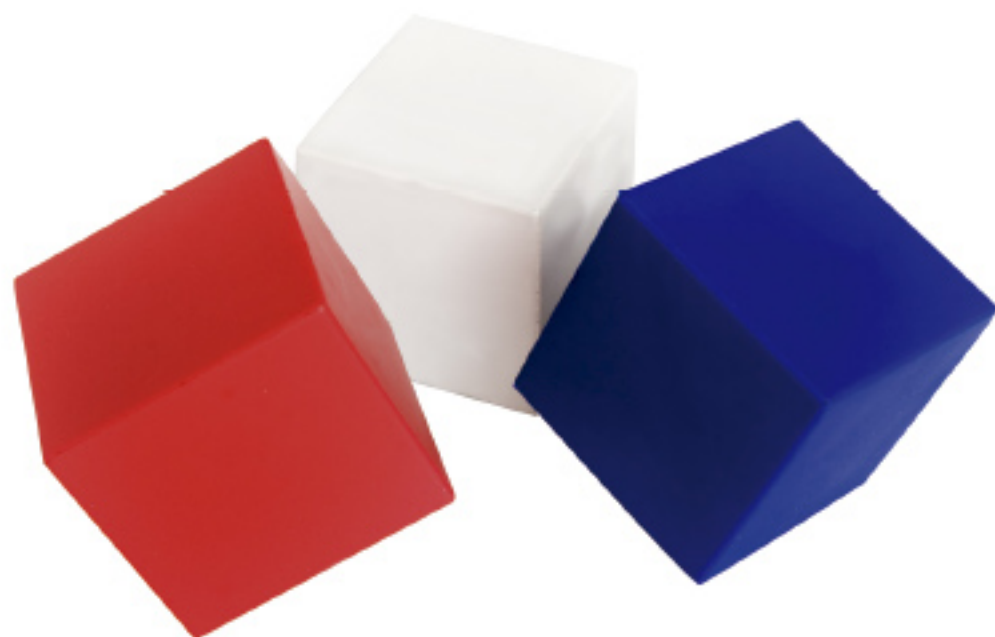

SB-08

Pastilla Antiestrés

Figura de pastilla antiestrés, fabricada en poliuterano.

Impresión: Tampografía.

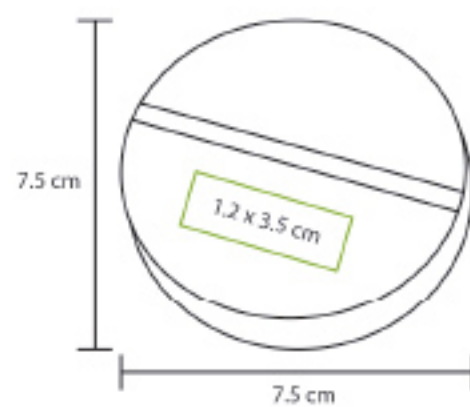

SB-09

Casa Antiestrés

Figura de casa antiestrés, fabricada en poliuterano.

Colores: Gris/blanco y rojo/blanco.
Impresión: Tampografía.

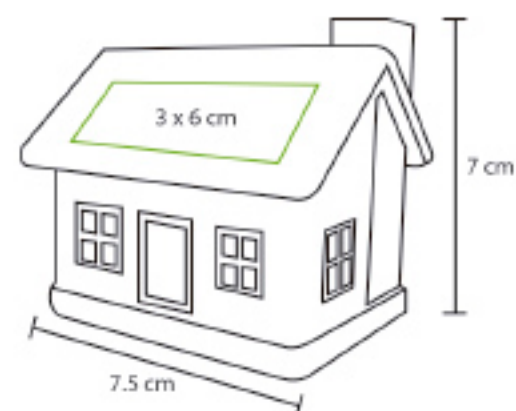

SB-10

Vaca Antiestrés

Figura de vaca antiestrés, fabricada en poliuterano.
Impresión: Tampografía.

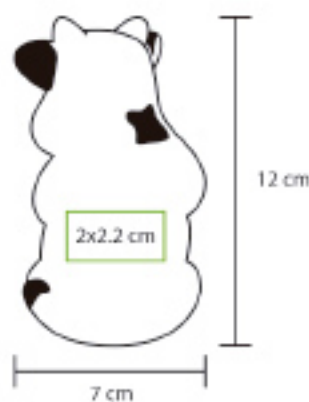

SB-11

Pelota Antiestrés

Pelota antiestrés lisa, fabricada en poliuterano.
Colores: Azul, rojo, blanco, naranja, negro, morado, rosa, amarillo y verde.
Impresión: Tampografía.

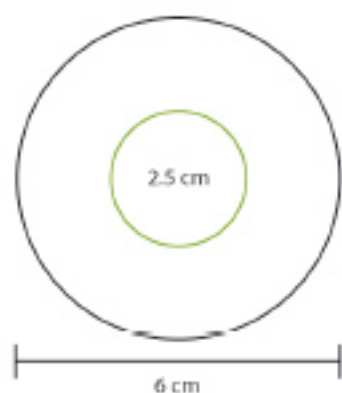

SB-12

Cerebro Antiestrés

Figura de cerebro antiestrés, fabricada en poliuterano.

Colores: Blanco y gris.
Impresión: Tampografía.

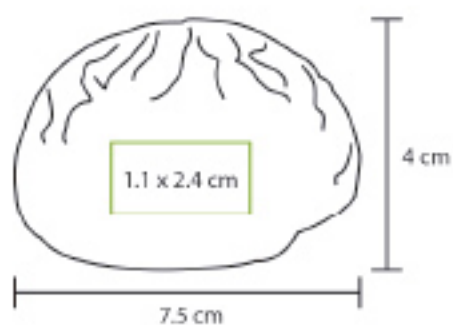

SB-13

Puerco Antiestrés

Figura de puerco antiestrés, fabricada en poliuterano.
Impresión: Tampografía.

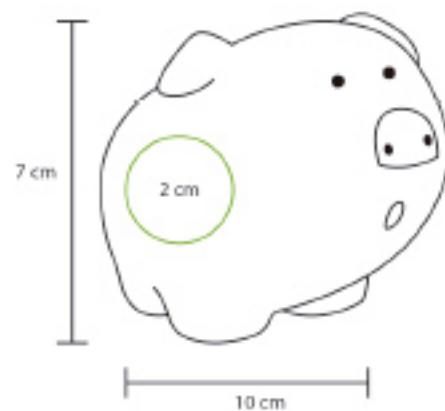

SB-14

Estrella Antiestrés

Figura de estrella antiestrés, fabricada en poliuterano.

Colores: Amarillo, azul y rojo.

Impresión: Tampografía.

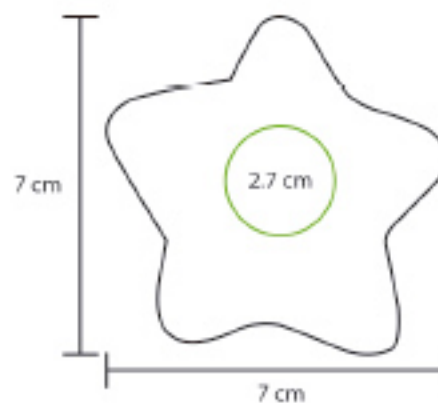



SB-15

Avión Antiestrés

Figura de avión antiestrés, fabricada en poliuterano.
Impresión: Tampografía.

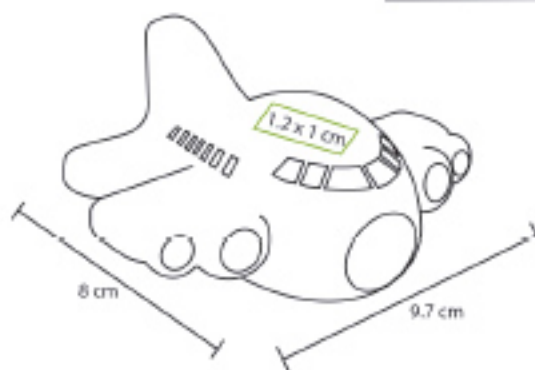

SB-16

Pelota Antiestrés

Pelota de playa antiestrés, fabricada en poliuterano.
Impresión: Tampografía.

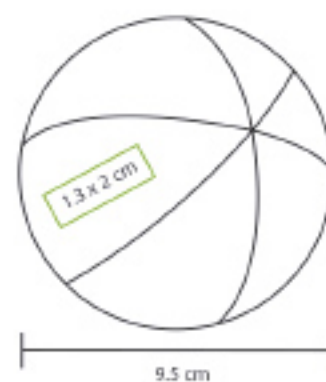

SB-17

Camioneta Antiestrés

Figura de camioneta antiestrés, fabricada en poliuterano.
Impresión: Tampografía.

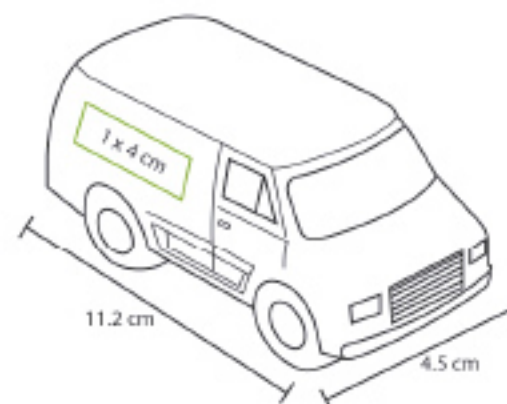



BAR



HM-07

Set de Vinos Merlot

Set para vino con 5 piezas en caja rectangular de madera.
Impresión: Serigrafía o grabado láser.

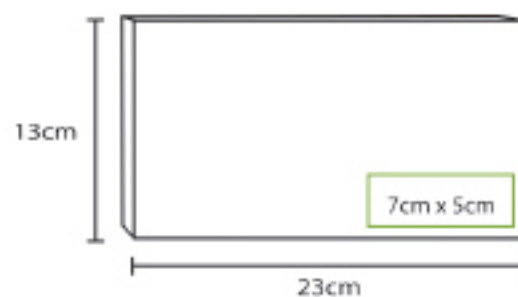

HM-08

Set de Vinos Syrah

Set para vino con 4 piezas en caja redonda de madera.
Impresión: Serigrafía o grabado láser.

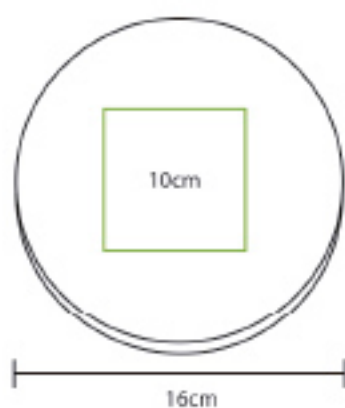

HM-11

Hielera Viena

Hielera rígida de plástico translúcida con asa.
Colores: Azul, blanco, negro (sólido) y rojo.
Impresión: Serigrafía o tampografía.

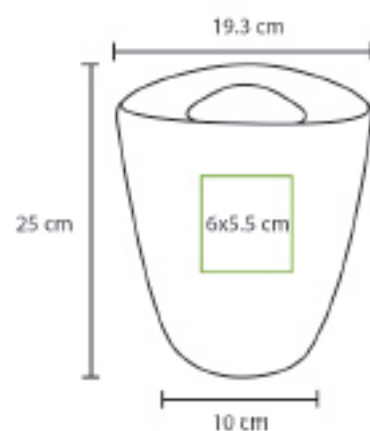

HM-13

Llavero Destapador

Llavero metálico con destapador.

Colores: Plata, azul, rojo y negro.

Impresión: Serigrafía o grabado láser.

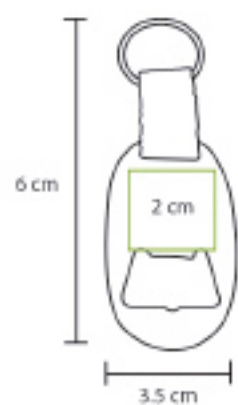

HM-16

Destapador

Destapador portatil de plástico.
Colores: Rojo, amarillo, verde, azul y negro.
Impresión: Serigrafía o tampografía.

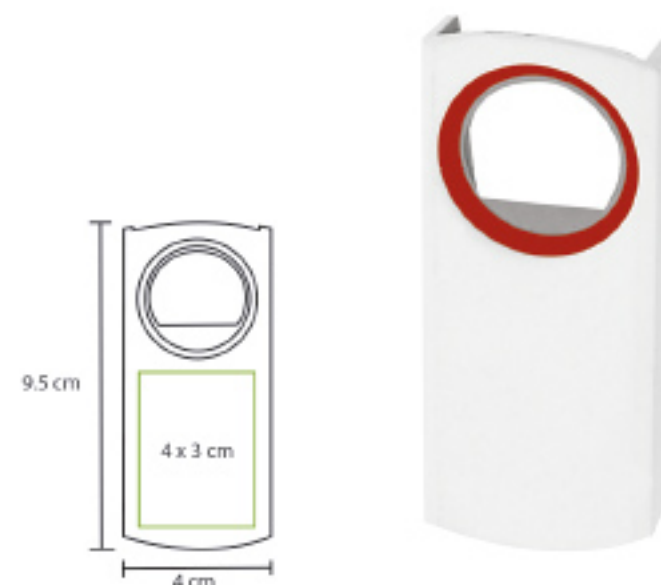

HM-17

Set Lyon

Set de vino con porta botella, saca corchos y correa fabricado en curpiel.
Impresión: Tampografía o grabado láser.

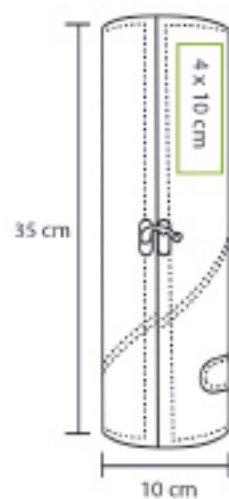

HM-19

Charola Torino

Charola fabricada en material PS.
Colores: Azul, negro y rojo.
Impresión: Serigrafía.

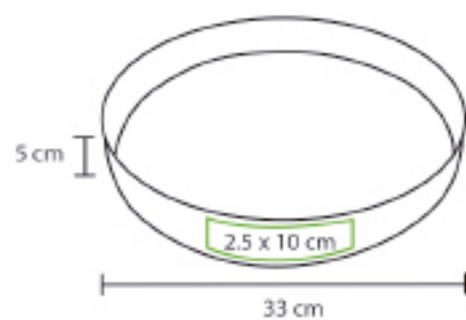

HM-21

Set Palermo

Set de vino con porta botellas y saca corchos, fabricado en MDF, cartón y terciopelo.
Impresión: Serigrafía o grabado láser.

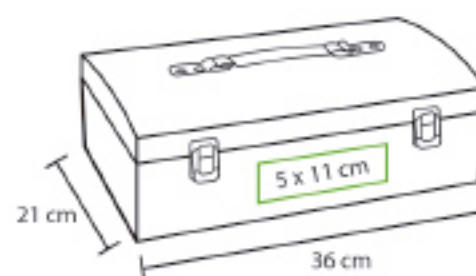

HM-23

Set Lugano

Set de juego para damas chinas y ajedrez, fabricado en cartón, plástico y terciopelo. Impresión: Serigrafía.

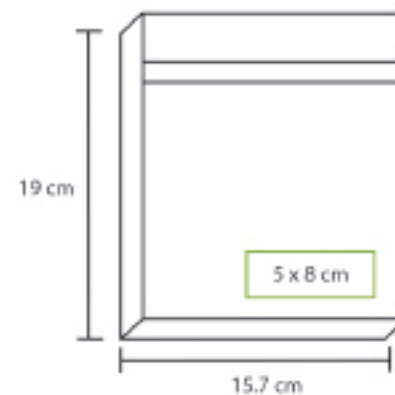

HM-22

Set Vacilea

Set de juego con cartas de plástico, dados y go fichas. Fabricado en plástico y terciopelo. Impresión: Serigrafía o grabado láser.

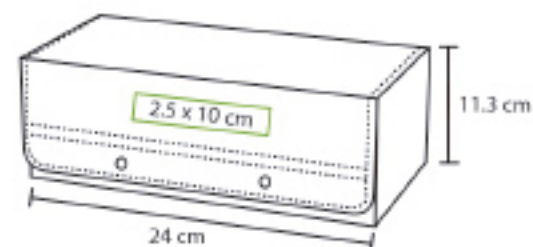



BELLEZA Y SALUD

BE-01

Espejo con Cepillo

Espejo con cepillo para bolsillo de plástico.
Impresión: Serigrafía o tampografía.

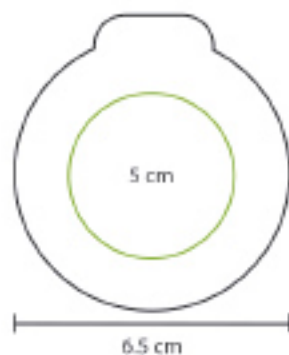

BE-02

Pastillero con Navaja

Pastillero doble de plástico con cortador.
Impresión: Serigrafía o tampografía.

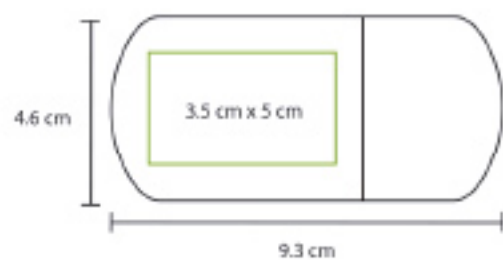

BE-03

Pastillero Rectangular

Pastillero de plástico con 6 compartimentos.

Colores: Azul, blanco y rojo.

Impresión: Serigrafía o tampografía.

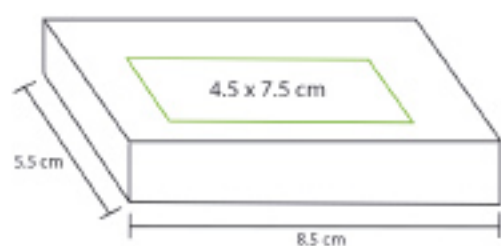

BE-04

Pastillero Redondo

Pastillero redondo de plástico con cortador.

Colores: Azul, rojo y blanco.

Impresión: Serigrafía o tampografía.

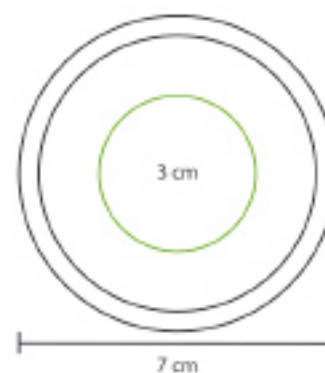

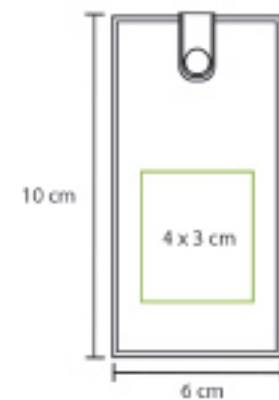

BE-05

Set de Manicure

Set de manicure de bolsillo.
Impresión: Serigrafía o tampografía.

BE-06

Espejo Redondo

Espejo redondo de plástico para bolsillo.
Colores: Blanco, azul, morado, rojo y naranja.
Impresión: Serigrafía o tampografía.

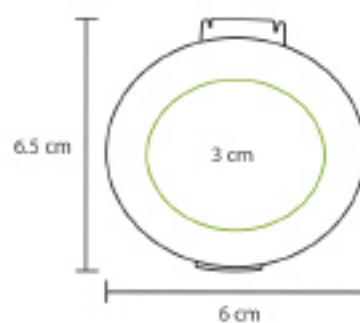

BE-07

Set Ovalado

Set de manicure ovalado de metal.
Impresión: Tampografía o serigrafía.



BE-08

Set de Brochas

Set de brochas en tubo metálico
con accesorios de plástico.
Impresión: Serigrafía o tampografía.



BE-09

Set de Manicure

Set de manicure en estuche de plástico.
Colores: Azul, rojo, blanco, gris, rosa y naranja.
Impresión: Serigrafía o tampografía.

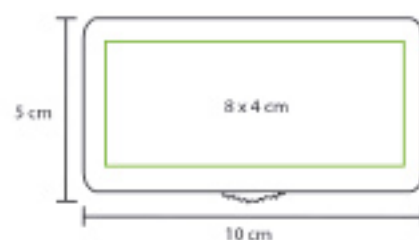



ST-10

Set Viena

Set de manicure con 6 piezas fabricado en acero inoxidable y estuche metálico.
Impresión: Serigrafía, grabado diamante o láser.

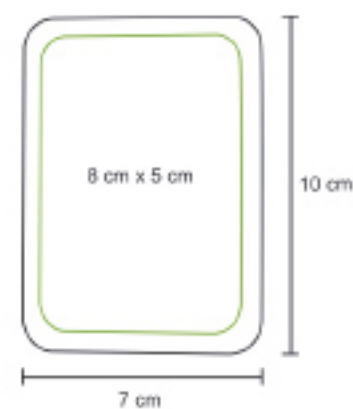

ST-11

Set Varsovia

Set de manicure ó piezas fabricado en acero inoxidable y estuche de curpiel.
Impresión: Serigrafía o grabado láser.

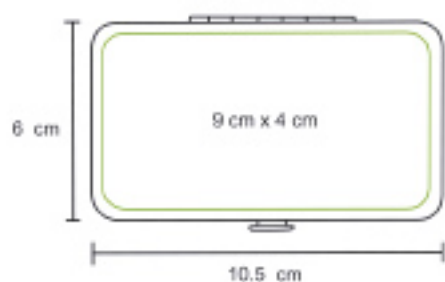

BE-10

Pulsera Nox

Pulsera fabricada en acero inoxidable y silicona.

Colores: Negro y blanco

Impresión: Serigrafía o grabado láser.

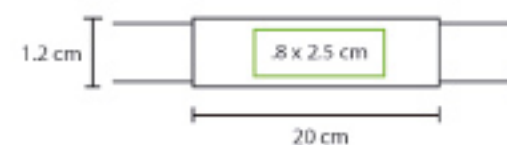

BE-11

Colgante Army

Colgante para cuello con placa metálica.

Impresión: Serigrafía o grabado láser.

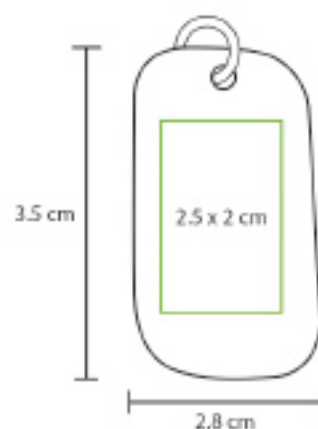



ECOLOGICA

BL-30

Bolígrafo Cairo

Bolígrafo ecológico con accesorios de plástico translúcido.

Colores: Verde, amarillo, rojo, azul y morado.

Impresión: Serigrafía o tampografía.

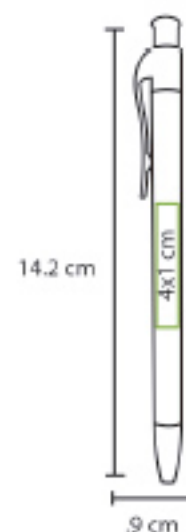

BL-49

Bolígrafo Ecológico

Bolígrafo ecológico con accesorios de plástico.

Colores: Verde, negro, azul y rojo.

Impresión: Serigrafía o tampografía.

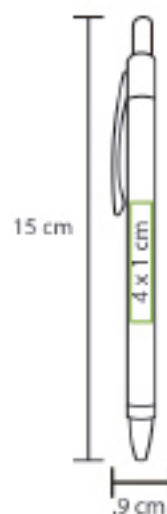

BL-63

Bolígrafo Eco Duo

Bolígrafo ecológico con marcatextos
y tapón de plástico.

Colores: Rosa, morado, amarillo, azul,
rojo y naranja.

Impresión: Serigrafía o tampografía.

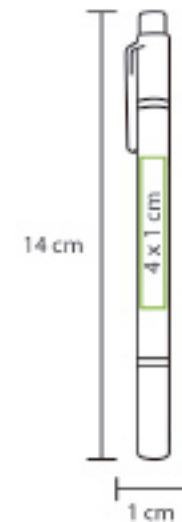

DK-38

Set de Notas Ecológico

Set ecológico de notas adhesivas y
banderitas de colores.

Impresión: Serigrafía o tampografía.

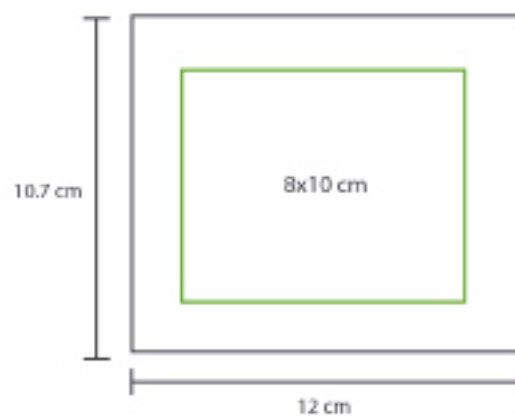

Set Ecológico Atlantis

Set escolar ecológico con goma, 3 lápices, regla y sacapuntas de madera.
Impresión: Serigrafía o tampografía.

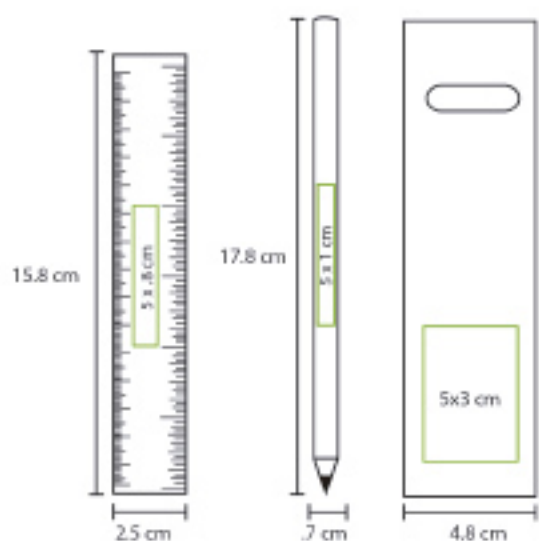

DK-46

Kit Turín

Kit de notas adhesivas ecológico.
Colores: Cartón, blanco y negro.
Impresión: Serigrafía.

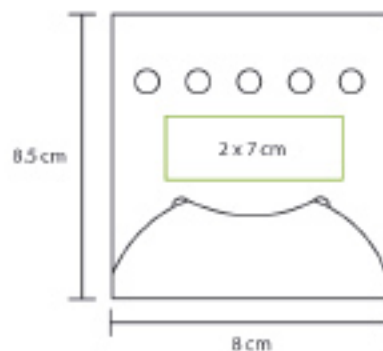

DK-47

Kit Roma

Kit de notas adhesivas, porta clips
y porta pluma ecológico con bolígrafo.
Impresión: Serigrafía.

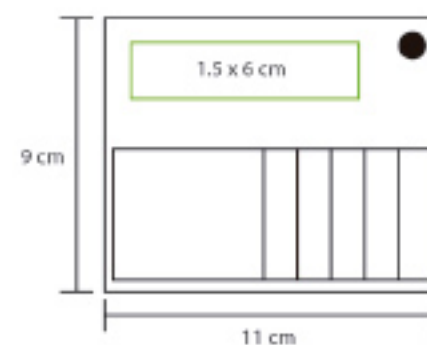

DK-48

Kit Milán

Kit de escritorio ecológico con
notas adhesivas, regla y bolígrafo.
Impresión: Serigrafía.

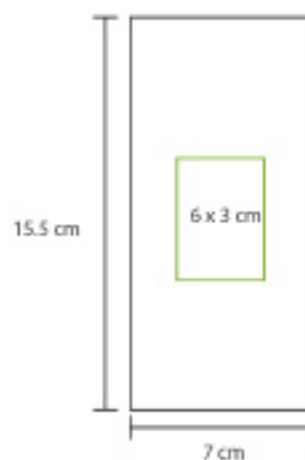

Libreta Ecológica

Libreta ecológica de pasta rígida con notas adhesivas.

Colores: Cartón, azul y rojo.

Impresión: Serigrafía o tampografía.

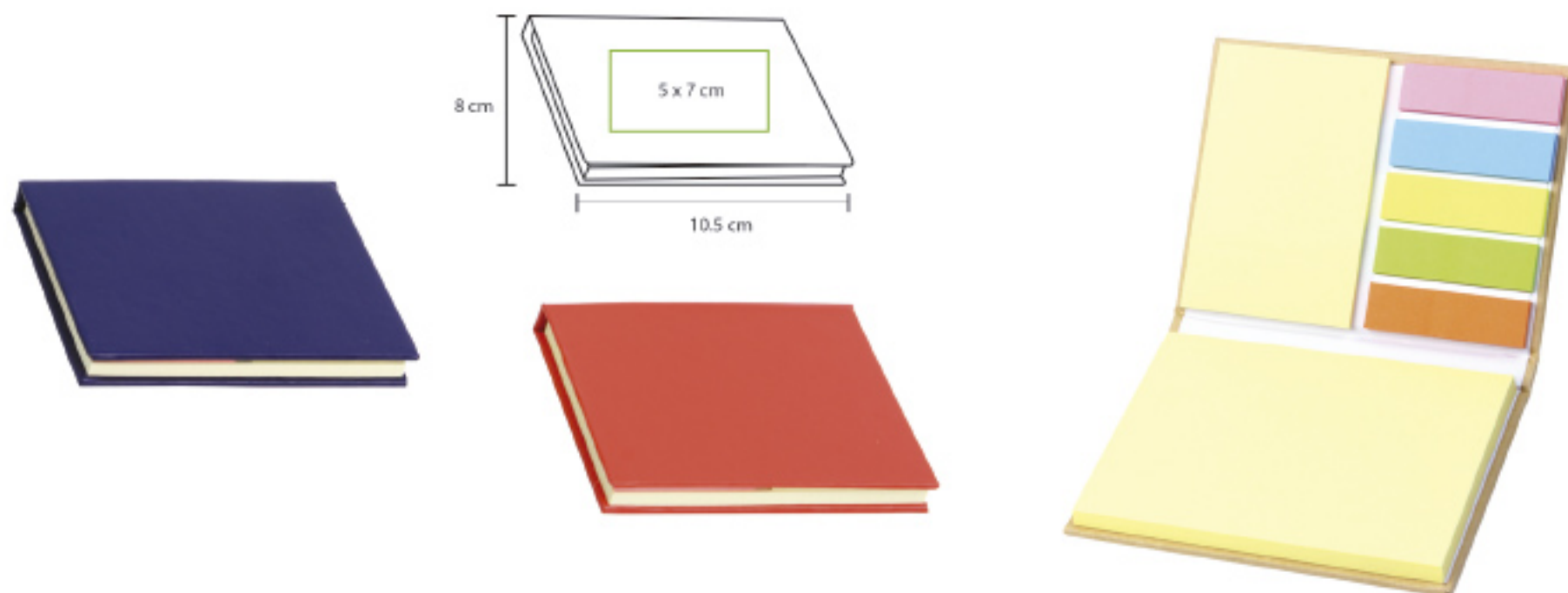

DK-50

Libreta Ecológica

Libreta ecológica de pasta rígida con notas adhesivas.

Colores: Cartón, azul y rojo.

Impresión: Serigrafía o tampografía.

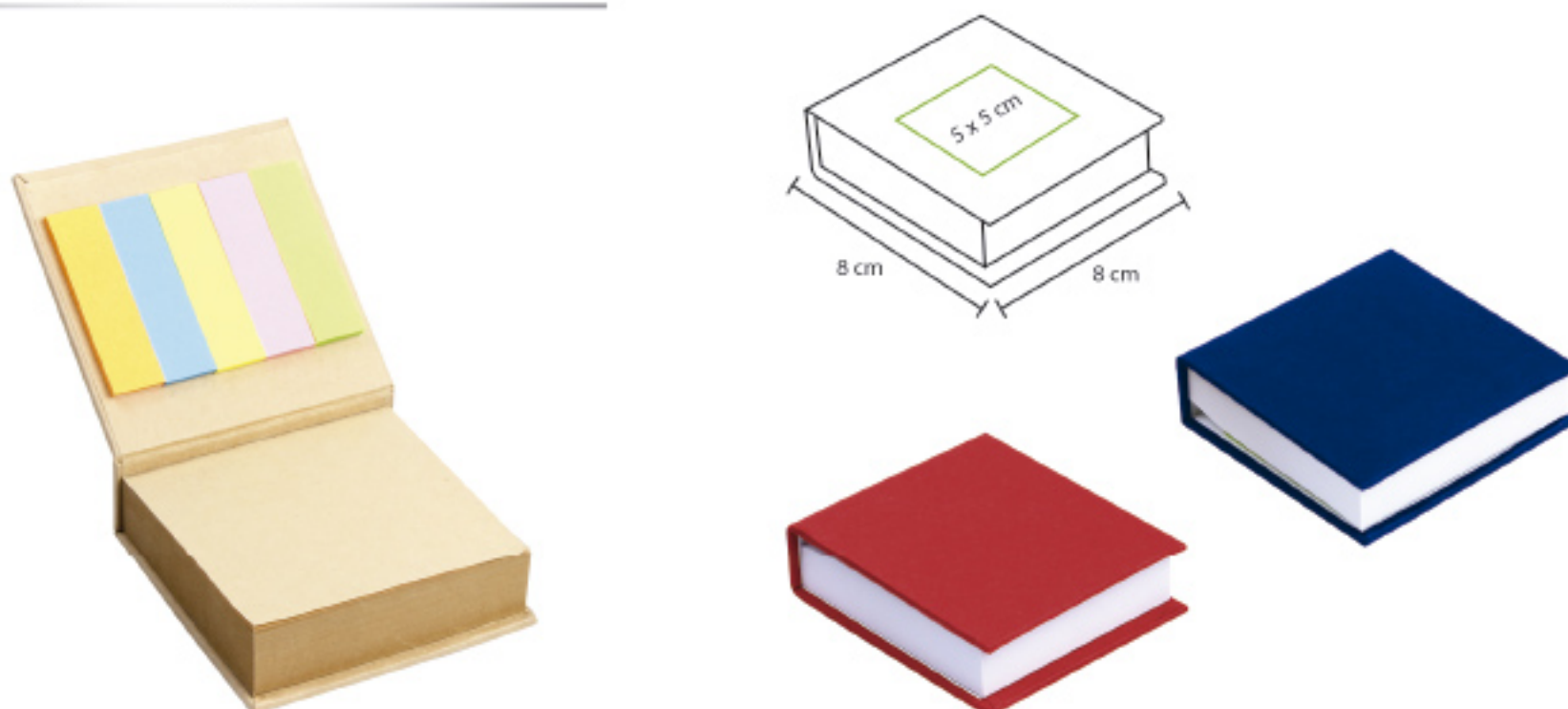

LB-02

Libreta Milán

Libreta biodegradable con pluma.

Colores: Negro, rojo, azul, amarillo, naranja y verde.

Impresión: Serigrafía o tampografía.

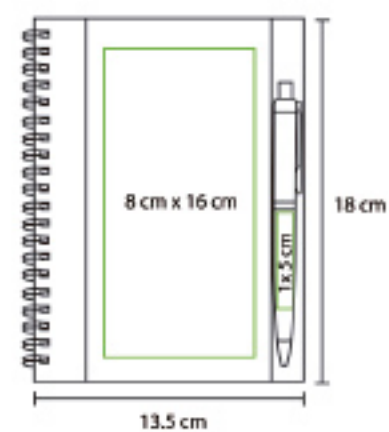

LB-03

Libreta Marsella

Libreta biodegradable pocket con pluma.
Colores: Negro, rojo, verde, amarillo y azul.
Impresión: Serigrafía o tampografía.

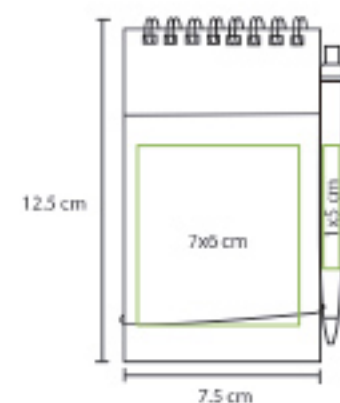

LB-05

Libreta Sydney

Libreta ecológica negra con pluma.
Colores: Verde, azul, naranja y rojo.
Impresión: Serigrafía o tampografía.

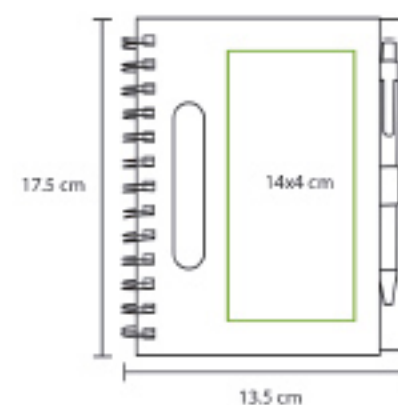

LB-06

Libreta Berlín

Libreta biodegradable con logo de recicla.

Colores: Rojo, negro, azul y naranja.

Impresión: Serigrafía o tampografía.

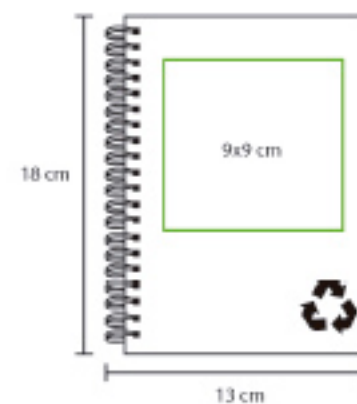

LB-08

Kit Ecológico

Cartera con notas adhesivas y pluma.

Impresión: Serigrafía.

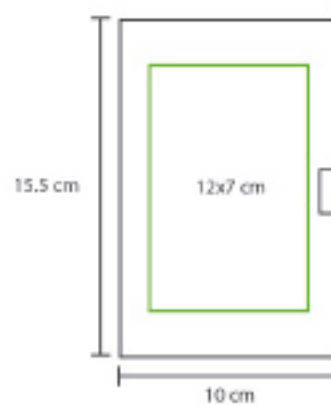

LB-10

Libreta Génova

Libreta ecológica con bolígrafo y notas adhesivas.
Colores: Negro, rojo, verde y azul.
Impresión: Serigrafía.

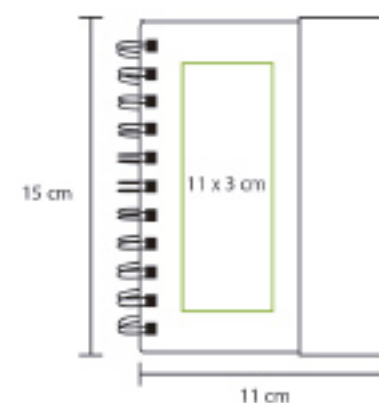

LB-11

Libreta Bolonia

Libreta ecológica con pluma.
Colores: Verde, azul, naranja, negro y rojo.
Impresión: Serigrafía.

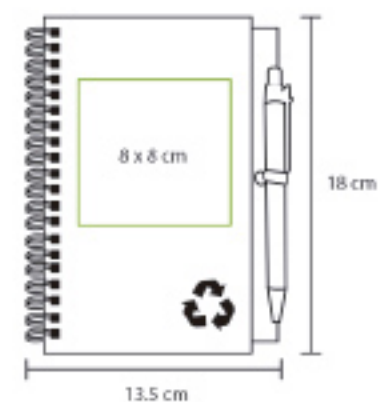

LB-12

Libreta Florencia

Libreta ecológica con bolígrafo.

Colores: Rojo, negro, azul, verde y naranja.

Impresión: Serigrafía.

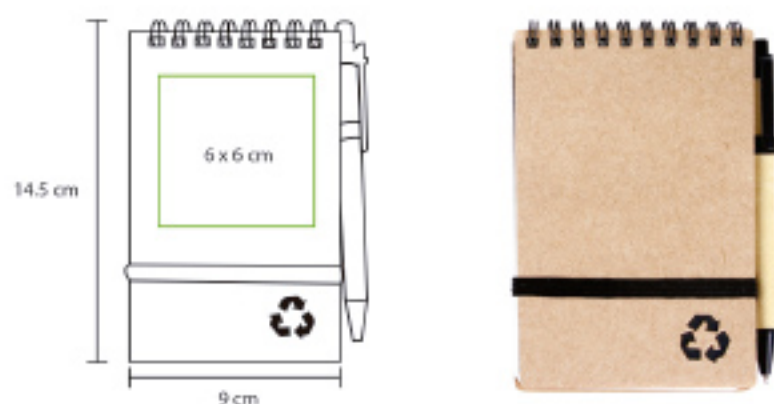

LB-18

Libreta Pamplona

Mini libreta ecológica con notas adhesivas y bolígrafo, fabricado en cartón y papel reciclado.

Colores: Negro, blanco y cartón.

Impresión: Serigrafía.

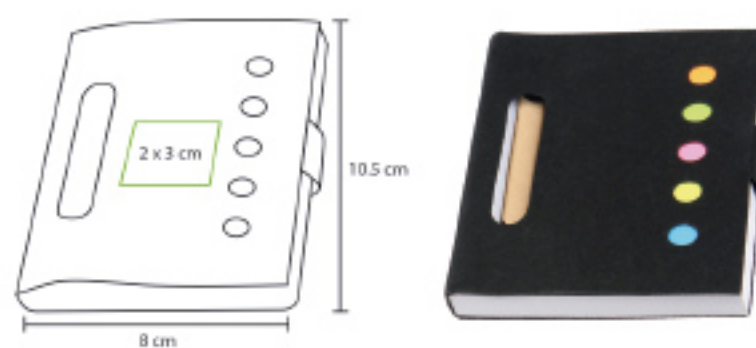



EJECUTIVA

Carpeta con Calculadora

Carpeta ejecutiva con calculadora tamaño carta.

No incluye bolígrafo.

Colores: Negro y café.

Impresión: Serigrafía o grabado láser.

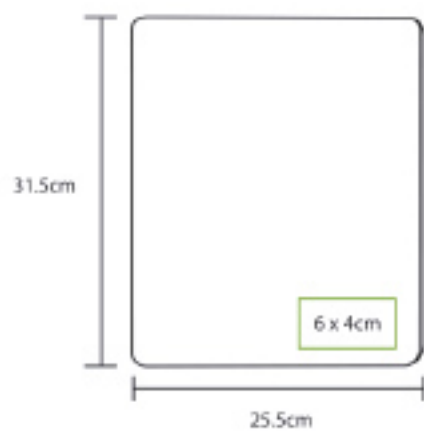

EX-08

Porta Tarjetas Ejecutivo

Porta tarjetas fabricado en curpiel con placa metálica.
Impresión: Grabado láser o diamante.

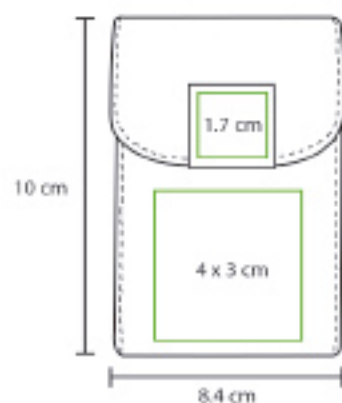

EX-09

Porta Tarjetas Metálico

Porta tarjetas ejecutivo liso.
Incluye caja de cartón.
Impresión: Grabado láser o diamante.



EX-28

Porta Tarjetas Metálico

Porta tarjetas metálico liso.
Impresión: Grabado láser o diamante.

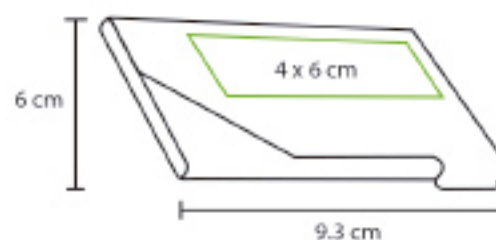

EX-10

Porta Tarjetas Ejecutivo

Porta tarjetas fabricado en curpiel con placa metálica.
Colores: Negro y café.
Impresión: Grabado láser o diamante.

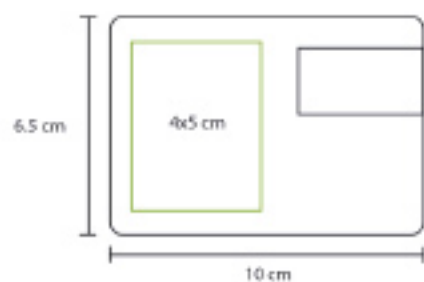

EX-12

Porta Notas Metálico

Libreta para notas con pluma, block de hojas y porta tarjetas.
Impresión: Serigrafía, grabado láser o diamante.

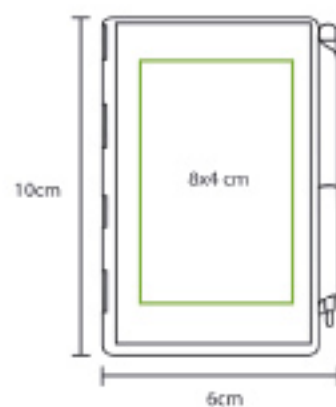

EX-18

Porta Tarjetas Ejecutivo Curvo

Porta tarjetas fabricado en curpiel con metal.
Impresión: Grabado láser.

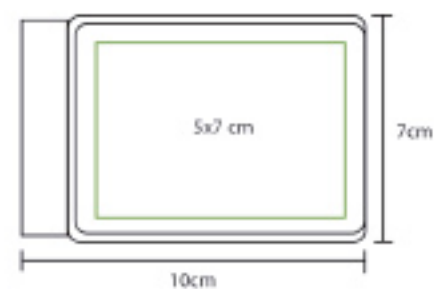

EX-19

Porta Tarjetas Ejecutivo

Porta tarjetas fabricado en curpiel y metal.
Impresión: Grabado láser.

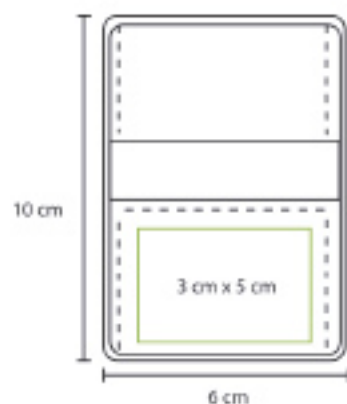

EX-20

Cartera London

Cartera fabricada en curpiel con placa metálica.
Impresión: Grabado láser.

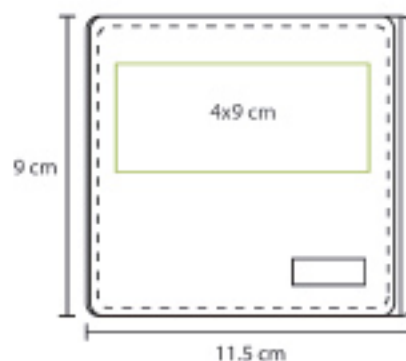

EX-21

Carpeta Berlin

Carpeta de lujo tipo portafolio, con
compartimentos interiores. No incluye bolígrafo.
Colores: Negro y café.
Impresión: Grabado láser.

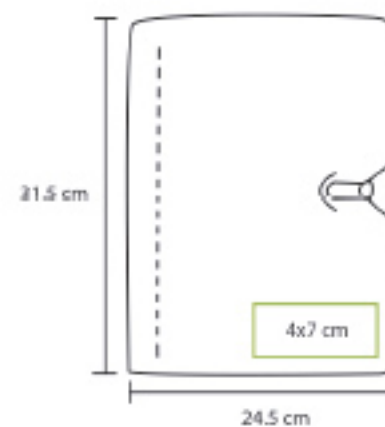

EX-22

Carpeta Sydney

Carpeta tipo portafolio con cierre y compartimentos interiores. No incluye bolígrafo.

Colores: Café y negro.

Impresión: Grabado láser.

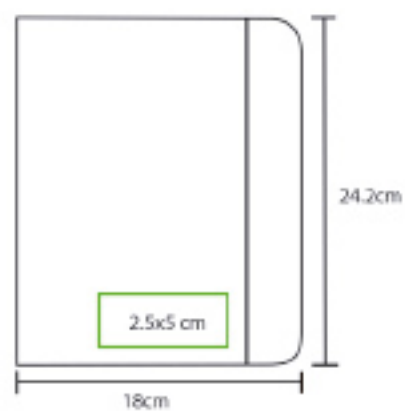

EX-23

Cartera Toronto

Cartera de curpiel con broche metálico.

Impresión: Grabado láser.

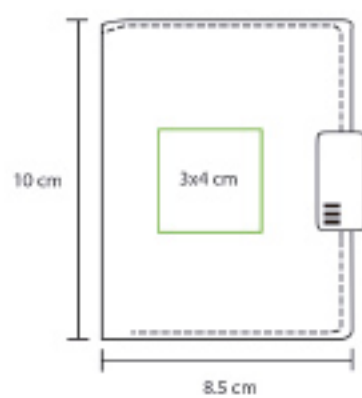

Carpeta Bangkok

Carpeta con compartimentos interiores y block.

Colores: Negro, azul y rojo.

Impresión: Serigrafía o grabado láser.





EX-25

Carpeta Taipei

Carpeta con compartimentos interiores y block.
Impresión: Grabado láser.

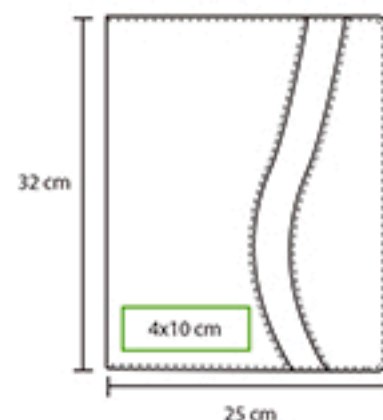

EX-44 ■■ ANTONIO MIRO ■■

Cartera

Cartera ejecutiva de polipiel, color negra.
Impresión: Serigrafía o grabado láser.

■■ ANTONIO MIRO ■■ EX-45

Porta Pasaporte

Porta pasaporte de polipiel, color negro.
Impresión: Serigrafía o grabado láser.



EX-32

Porta Tablet Aviñon

Porta tablet con bandas ajustables, cubierta de poliuretano, interior de terciopelo y poliuretano.

Colores: Negro, azul y rojo.

Impresión: Serigrafía o grabado láser.

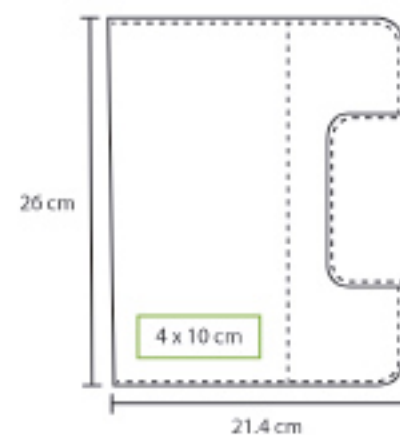

EX-33

Carpeta Ginebra

Carpeta con block para notas y porta tarjetas, fabricada en poliuretano. Incluye caja individual
Impresión: Serigrafía o grabado láser.

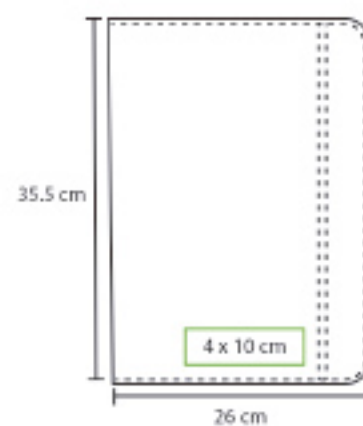

EX-34

Carpeta Lucerna

Carpeta porta tablet con cubierta de fibra de vidrio y poliuretano, interior en curpiel.
Impresión: Serigrafía o grabado láser.

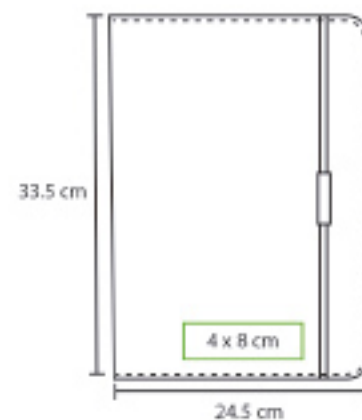

Ejecutiva

EX-35

Maletín Sektor

Maletín ejecutivo fabricado en poliéster con bolsillo acolchonado para portátil. Impresión: Serigrafía.

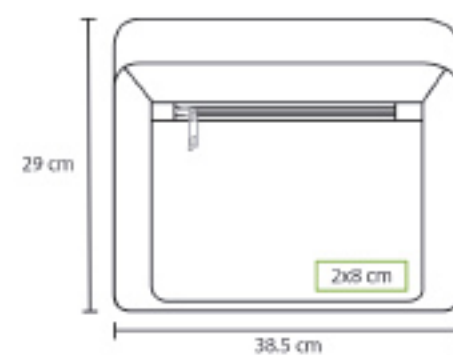

EX-36

Maletín Chipset

Maletín ejecutivo fabricado en poliéster con bolsillo acolchonado para portátil. Colores: Negro y gris. Impresión: Serigrafía.

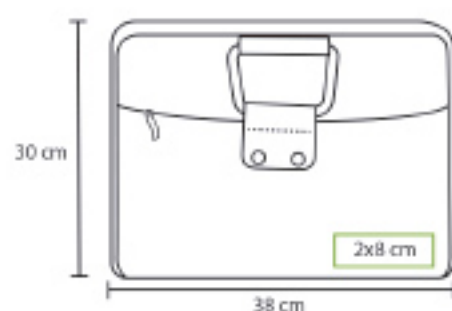

■■ ANTONIO MIRO ■■ **EX-37**

Maletín Ascott

Maletín ejecutivo fabricado en poliéster con bolsillo acolchonado para portátil. Impresión: Serigrafía.

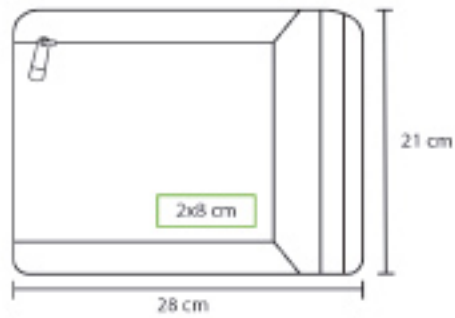

NUEVO



EX-38

Portadocumentos Tempo

Portadocumentos fabricado en poliéster con bolsillo acolchonado para portátil.

Colores: Gris y negro.
Impresión: Serigrafía.

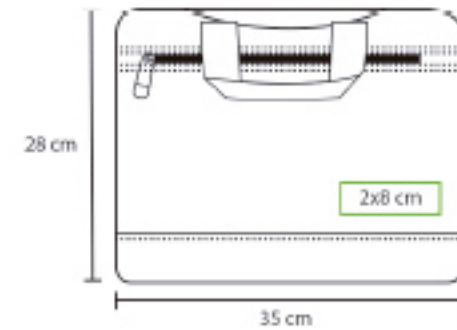

NUEVO





■■ ANTONIO MIRO ■■ EX-39

Maletin Sysko

Maletin fabricado en poliéster con bolsillo acolchonado para portátil. Impresión: Serigrafía.

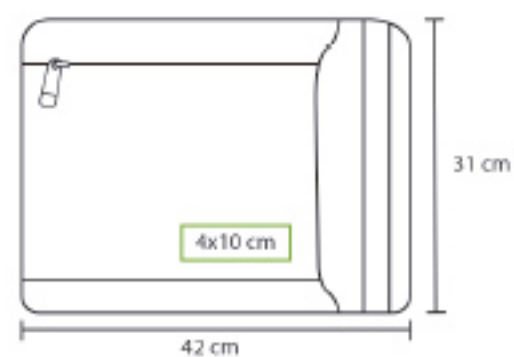

EX-40 ■■ ANTONIO MIRO ■■

Mochila Karpal

Mochila fabricado en poliéster con bolsillo acolchonado para portátil. Impresión: Serigrafía.



ST-05

Set de Regalo Masaryk

Set de llavero con pluma metálica.
Impresión: Serigrafía, grabado láser o diamante.

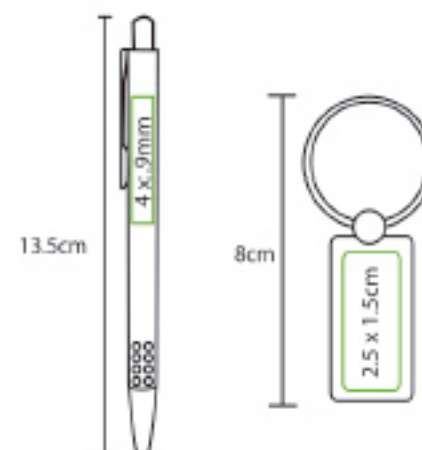

ST-06

Set de Regalo Condesa

Pluma con llavero metálico redondo.
Impresión: Serigrafía, grabado láser o diamante.





■■ ANTONIO MIRO ■■ TH-31

Set de Computo

Set de computo con 5 piezas, fabricado en piel, color negro. Impresión: Serigrafía.

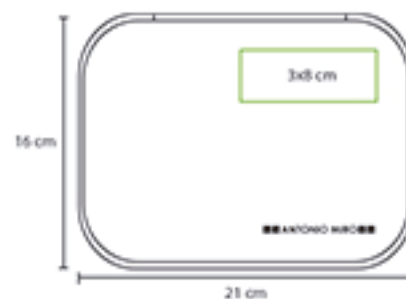

EX-41 ■■ ANTONIO MIRO ■■

Mochila Bruselas

Mochila con cintas y parte trasera acolchonadas con compartimento para laptop, color negro. Impresión: Serigrafía.



■■ ANTONIO MIRO ■■ EX-43

Maleta Rigida

Maleta Trolley rigida con chapa de seguridad, color negro. Impresión: Serigrafía.





ESCOLARES Y NIÑOS

Set de Escritura 5 en 1

Set de plástico con bolígrafos, lápiz y marca textos.

Colores: Rojo, azul y negro.

Impresión: Serigrafía o tampografía.

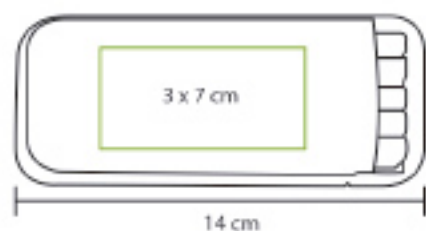

DK-41

Set Ecológico Atlantis

Set escolar ecológico con goma, 3 lápices, regla y sacapuntas de madera.

Impresión: Serigrafía o tampografía.

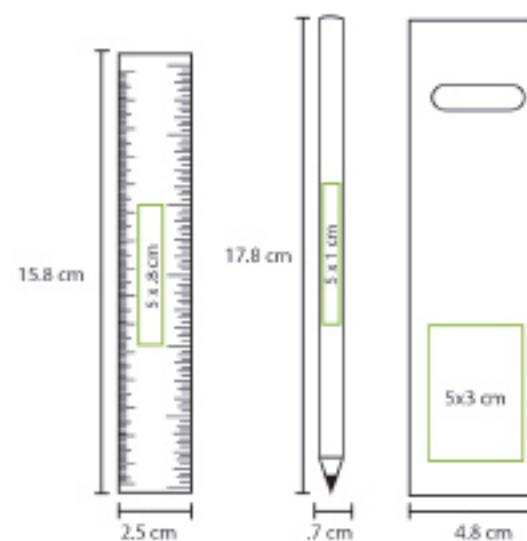

DK-55

Regla con Calculadora

Regla de 20 cm de plástico con calculadora.

Colores: Azul, plata y rojo.

Impresión: Serigrafía o tampografía.

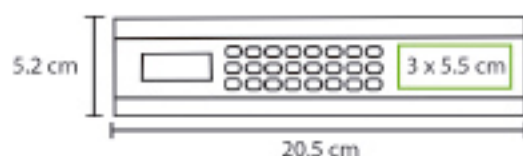

KD-07

Lapicera Escolar

Lapicera fabricada en PVC con calculadora.

No incluye accesorios.

Colores: Negro, azul y rojo.

Impresión: Serigrafía.

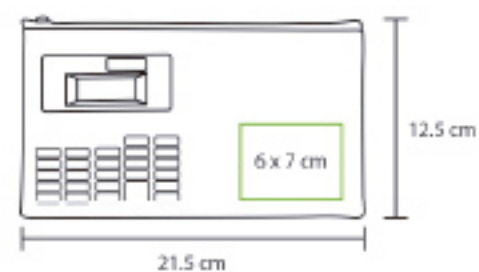

Contenedor para Lunch

Contenedor de plástico con cubiertos.

Colores: Rojo y azul.

Impresión: Serigrafía o tampografía.

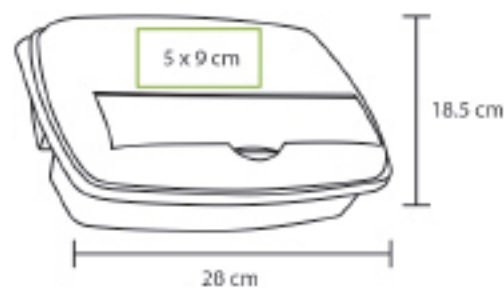

HM-12

Easy Lunch

Dos contenedores de plástico con cubiertos.

Colores: Rojo y azul.

Impresión: Serigrafía o tampografía.



LB-01

Libreta Escolar

Libreta con cubierta de plástico y estuche con cierre.

No incluye accesorios.

Colores: Verde, humo, rojo y azul.

Impresión: Serigrafía o tampografía.

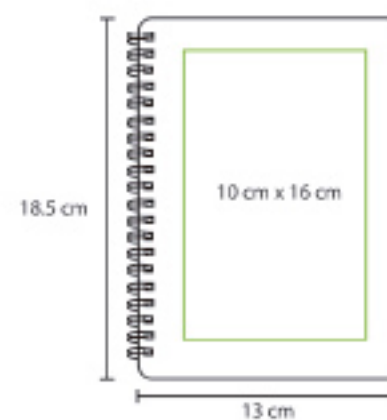

LB-02

Libreta Milán

Libreta biodegradable con pluma.

Colores: Negro, rojo, azul, amarillo, naranja y verde

Impresión: Serigrafía o tampografía.

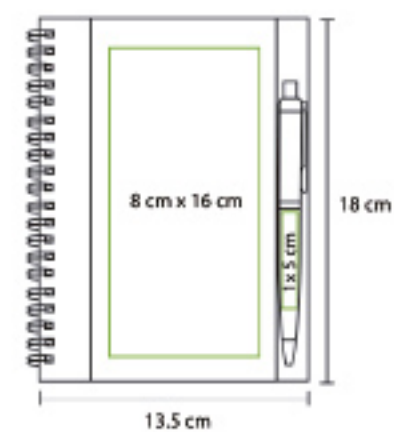

LB-03

Libreta Marsella

Libreta biodegradable pocket con pluma.
Colores: Negro, rojo, verde, amarillo y azul.
Impresión: Serigrafía o tampografía.

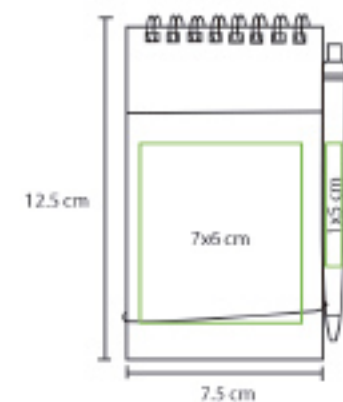

LB-12

Libreta Florencia

Libreta ecológica con bolígrafo.

Colores: Rojo, negro, azul, verde y naranja.
Impresión: Serigrafía.

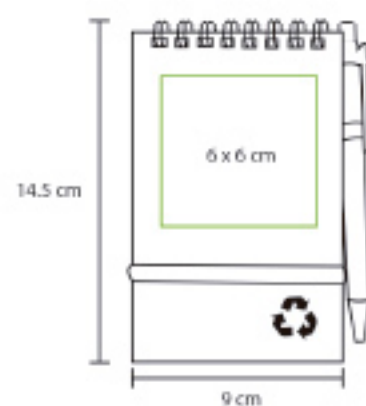

Cilindro Mini Valencia

Cilindro fabricado en policarbonato con tapa de aluminio /350 ml.

Colores: Azul, blanco, rojo, rosa, naranja, humo y morado.

Impresión: Tampografía.

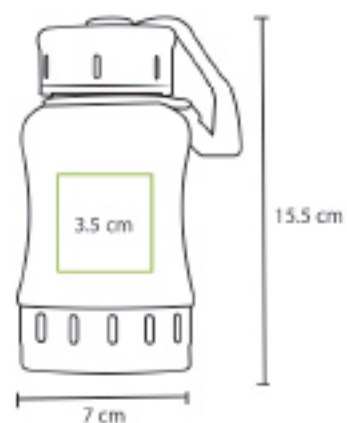

TX-19

Lapicera

Bolsa lapicera de micro fibra.
Colores: Negro, rojo, rosa y azul.
Impresión: Serigrafía.

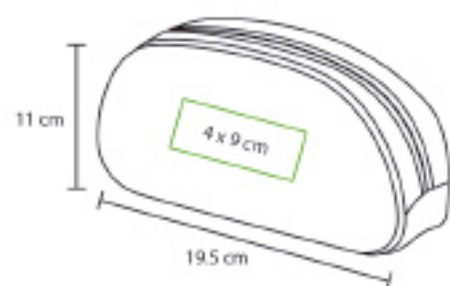

TX-23

Mochila Bari

Mochila back pack escolar fabricada en PVC.
Colores: Rojo, negro y azul.
Impresión: Serigrafía o bordado.

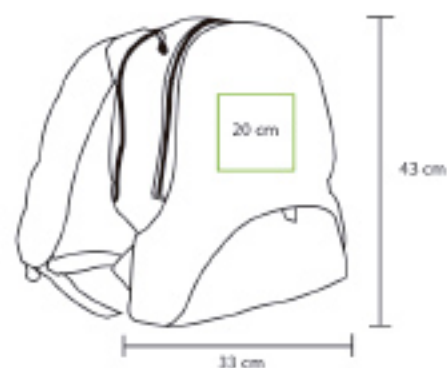

Mochila Arezzo

Mochila back pack fabricada en loneta con nylon.

Colores: Verde, naranja, negro, gris, azul y rojo.

Impresión: Serigrafía o bordado.

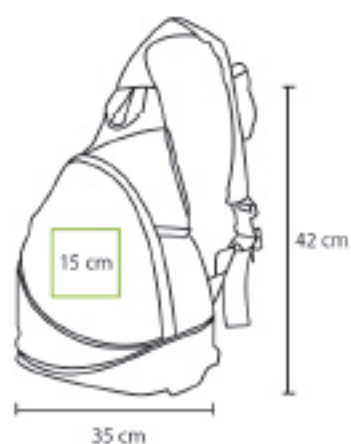

TX-14

Mochila Escolar

Mochila back pack.

Colores: Naranja, negro, azul y rojo.
Impresión: Serigrafía o bordado.



TX-37

Hielera Niza

Hielera térmica con forro PEVA fabricada en Non-woven.

Colores: Naranja, azul, rojo y verde.

Impresión: Serigrafía.



TX-35

Mochila Taipei

Mochila Trolley con ruedas, fabricada en poliéster con la parte trasera y cintas acolchonadas.

Colores: Rojo, azul y naranja.
Impresión: Serigrafía o bordado.



KD-10

Set Cafey

Sacapuntas de plástico con goma.

Colores: Rojo y azul.

Impresión: Tampografía o serigrafía.

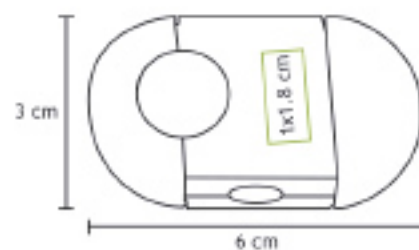

LL-16

Llvero Niño

Llavero metálico en forma de niño.

Impresión: Serigrafía, grabado láser o diamante.

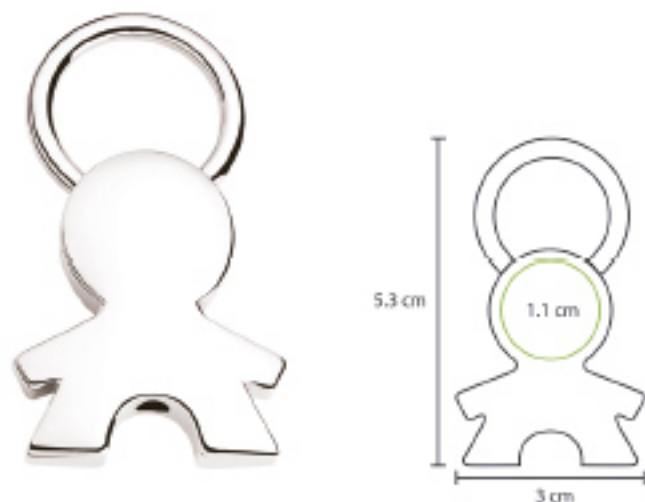

LL-17

Llvero Niña

Llavero metálico en forma de niña.

Impresión: Serigrafía, grabado láser o diamante.

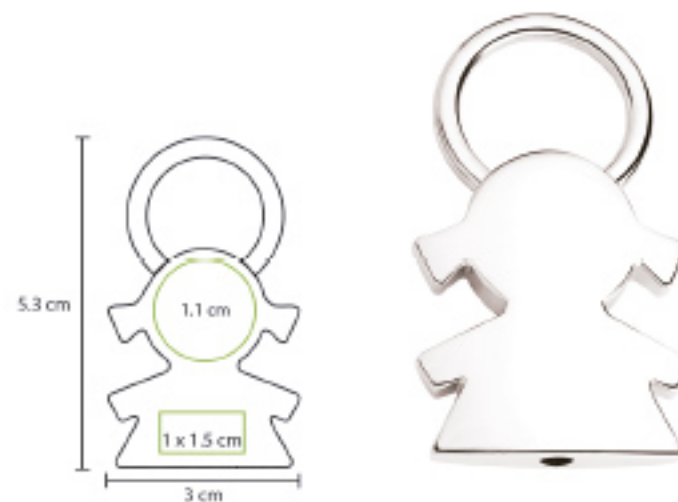

BL-19

Lapicero Zúrich

Lapicero portaminas de plástico con goma.

Colores: Azul, rojo, verde y blanco.

Impresión: Serigrafía o tampografía.



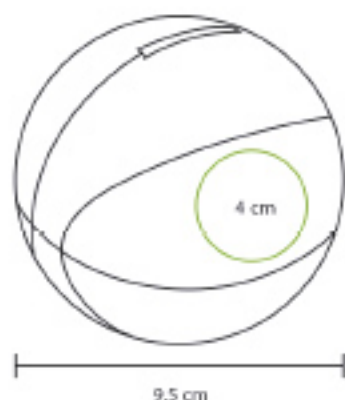

KD-02

Alcancía Basketball

Alcancía de plástico en forma de balón de basketball.
Impresión: Tampografía.

KD-03

Alcancía Tennis

Alcancía de plástico en forma de pelota de tennis.
Impresión: Tampografía.

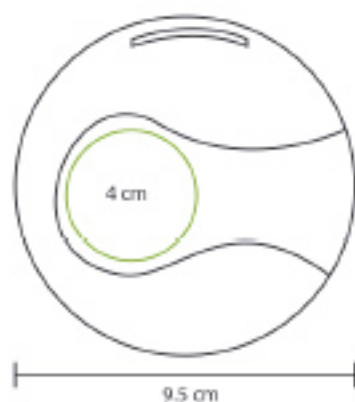

KD-04

Alcancía Soccer

Alcancía de plástico en forma de balón de soccer.
Impresión: Tampografía.



KD-06

Alcancia Nuovo

Alcancia de plástico con ventana al frente.
Colores: Verde, naranja, morado y rosa
Impresión: Tampografía.

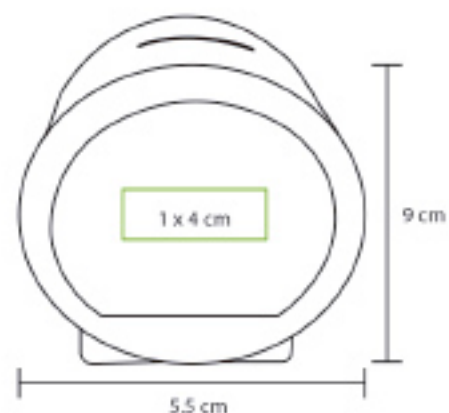

KD-09

Alcancia de Cerdito

Alcancia en forma de cerdito fabricada en PVC.
Colores: Rojo, rosa, amarillo, verde y azul.
Impresión: Tampografía.



Portaretrato Rompecabezas

Portaretrato de plástico para fotografía de 9x13 cm.

Colores: Verde, azul, amarillo, naranja y rosa.

Impresión: Serigrafía.

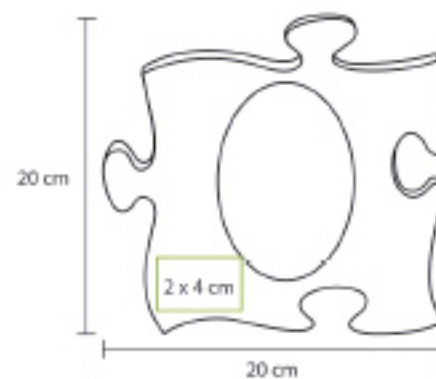

DK-26

Clip Portanotas Niño

Portanotas metálico en forma de niño.

Impresión: Grabado láser o diamante.

DK-27

Clip Portanotas Niña

Portanotas metálico en forma de niña.

Impresión: Grabado láser o diamante.

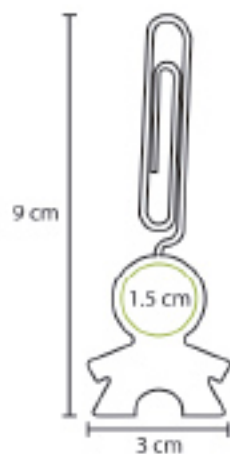

Reloj de Pulso

Reloj con caja metálica con dial giratorio y correa de plástico.

Incluye estuche metálico.

Colores: Azul marino, rojo, negro, azul y naranja.

Impresión: Serigrafía o tampografía.



RP-30

Reloj de Pulso

Reloj de plástico con estuche de plástico.

Colores: Verde, azul, negro y rojo.

Impresión: Serigrafía o Impresión digital.



RP-44

Reloj de Pulso

Reloj fabricado en silicón.

Colores: Negro, azul, rojo, rosa, blanco y morado.

Impresión: Serigrafía o Impresión digital.

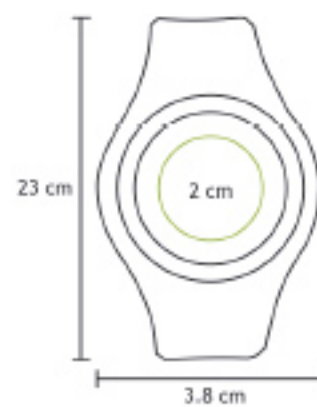

RP-43

Reloj de Pulso

Reloj de brazalete flexible. No incluye estuche.
Colores: Rojo, azul, rosa, morado, blanco y negro.
Impresión: Serigrafía o impresión digital.



TE-13

Cilindro Deportivo City

Cilindro deportivo curvo con tapa de plástico.
Capacidad de 900 ml.
Colores: Azul, gris, rojo y naranja.
Impresión: Tampografía.

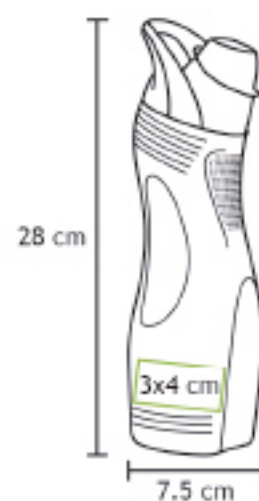



ESCRITURA



BL-01

Bolígrafo Multifunciones

Bolígrafo metálico con señalador láser y luz.
Tinta de escritura negra.
Impresión: Serigrafía, grabado láser o diamante.

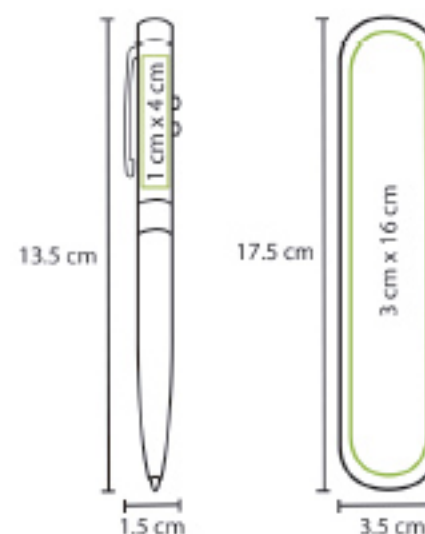

BL-02

Pluma 4 en 1

Bolígrafo metálico con funciones de lapicero,
tinta negra, tinta roja y PDA. Incluye estuche.
Impresión: Serigrafía, grabado láser o diamante.

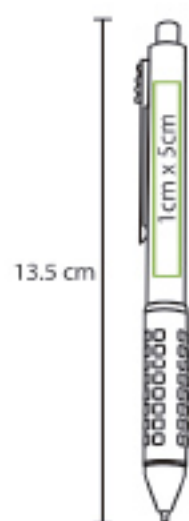

BL-03

Bolígrafo Multifunciones

Bolígrafo metálico con luz led, PDA y señalador láser.

Incluye estuche.

Impresión: Serigrafía o grabado diamante.

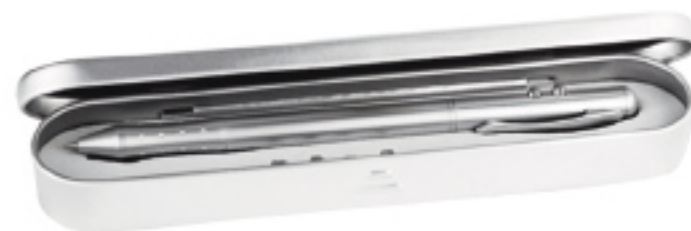
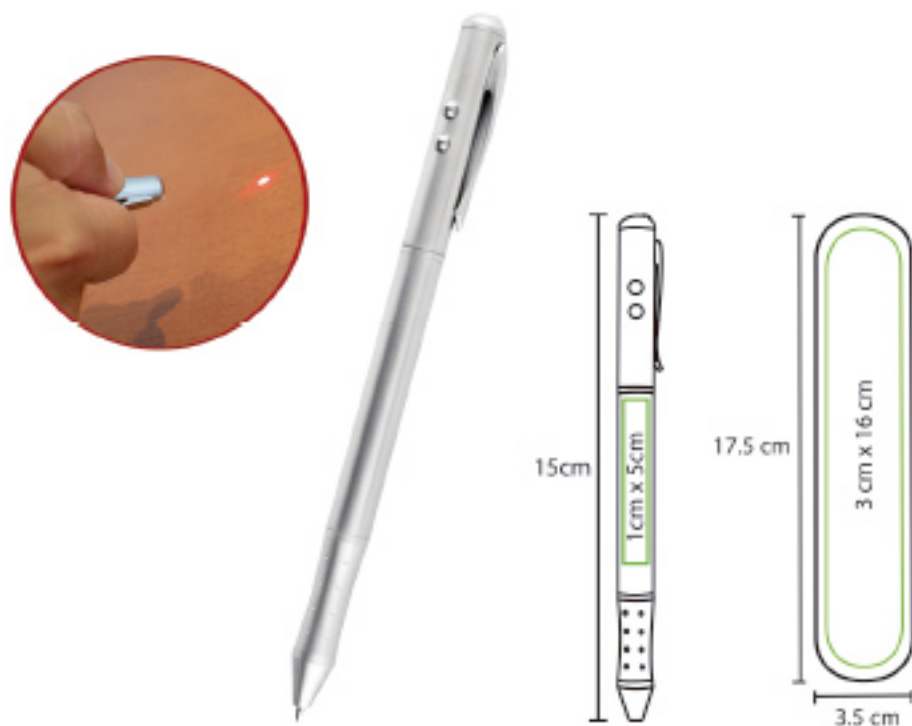

BL-05

Bolígrafo Máster

Bolígrafo metálico retráctil en color vino con grip.

Incluye estuche.

Impresión: Serigrafía o grabado láser.

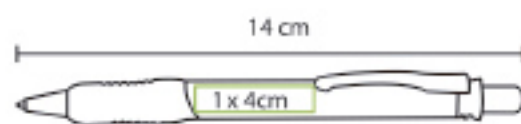

BOLÍGRAFOS



BL-07

Bolígrafo Multifunciones

Bolígrafo metálico con señalador láser.

Incluye estuche.

Impresión: Serigrafía, grabado láser o diamante.



BL-08

Bolígrafo Vader

Bolígrafo metálico retráctil. Incluye estuche.

Impresión: Serigrafía, grabado láser o diamante.



BL-09

Bolígrafo Piere

Bolígrafo metálico retráctil.

Colores: Negro y plata.

Impresión: Serigrafía o grabado láser.

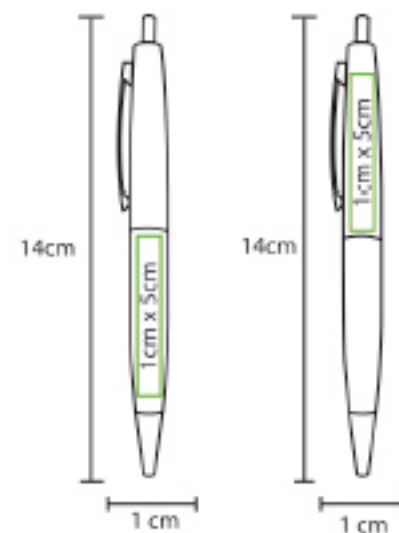

BL-10

Bolígrafo Roulette

Bolígrafo con plástico y metal con grip. Incluye estuche.

Colores: Naranja, rojo, blanco, azul, negro y amarillo.

Impresión: Serigrafía o tampografía.

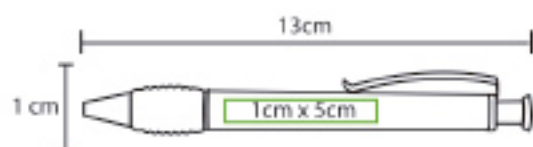

BOLÍGRAFOS



BL-11

Bolígrafo Praga

Bolígrafo metálico. Incluye estuche.
Colores: Negro, azul y vino.
Impresión: Serigrafía o grabado láser.



BL-12

Bolígrafo Celica

Bolígrafo metálico twist. Incluye estuche.
Colores: Plata, negro, naranja, rosa, verde y azul.
Impresión: Serigrafía o grabado láser.

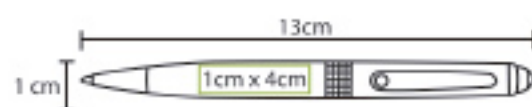

BL-17

Bolígrafo Thai

Bolígrafo de plástico retráctil.
Colores: Verde, azul, blanco y rosa.
Impresión: Serigrafía o tampografía.

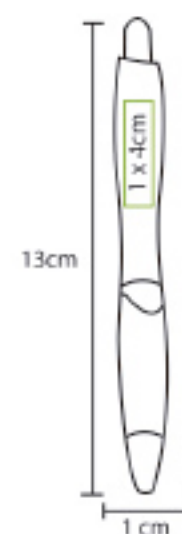

BL-18

Bolígrafo Capri

Bolígrafo con plástico con accesorios metálicos.
Colores: Naranja, rojo, verde y azul.
Impresión: Serigrafía o tampografía.

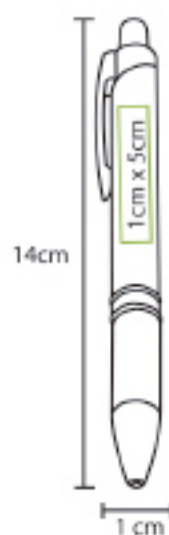

Lapicero Zúrich

Lapicero portaminas de plástico translúcido con goma.

Colores: Azul, rojo, verde y blanco.
Impresión: Serigrafía o tampografía.



BL-20

Bolígrafo Multifunciones

Bolígrafo metálico con luz led y señalador láser.

Incluye estuche.

Impresión: Serigrafía o tampografía.

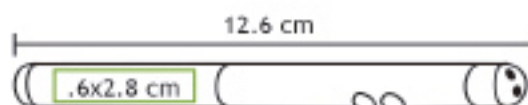

BL-21

Bolígrafo Sevilla

Bolígrafo de plástico.

Colores: Verde, rojo, naranja, rosa, azul y negro.

Impresión: Serigrafía o tampografía.

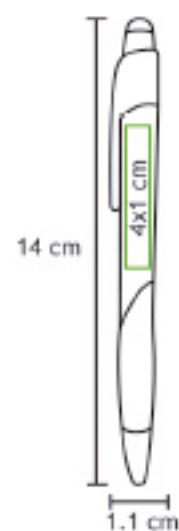

BL-22

Bolígrafo Vigo

Bolígrafo con plástico retráctil.

Colores: Plata, verde, negro, azul y rojo.

Impresión: Serigrafía o tampografía.

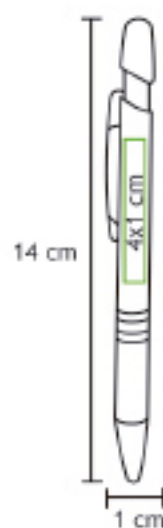

BL-23

Bolígrafo Toledo

Bolígrafo de plástico retráctil.
Colores: Rojo, plata, azul, humo y verde.
Impresión: Serigrafía o tampografía.

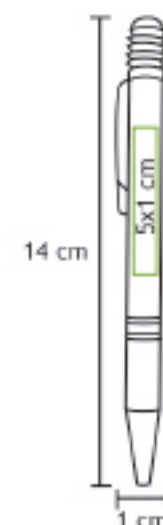

BL-24

Bolígrafo Málaga

Bolígrafo de plástico blanco con detalles en color.
Colores: Verde, negro, rojo, naranja y azul.
Impresión: Serigrafía o tampografía.

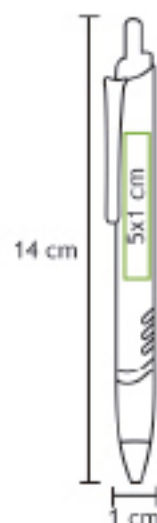

BL-25

Bolígrafo Delhi

Bolígrafo de plástico con navaja.
Impresión: Serigrafía o tampografía.

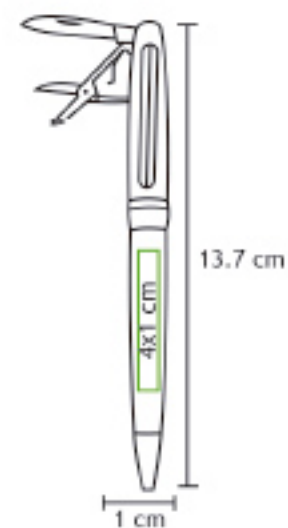

BL-26

Bolígrafo Tenerife

Bolígrafo de plástico con accesorios color plata.
Colores: Negro, azul, rojo, verde y morado.
Impresión: Serigrafía o tampografía.

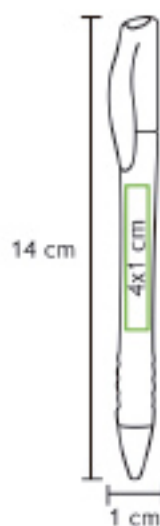

Bolígrafo Bilbao

Bolígrafo de plástico con grip.
Colores: Rojo, gris, verde, azul, morado y naranja.
Impresión: Serigrafía o tampografía.

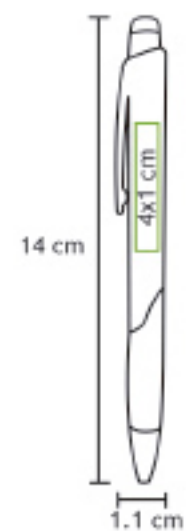

BL-28

Bolígrafo Barcelona

Bolígrafo de plástico con grip.
Colores: Verde, naranja, rojo y azul.
Impresión: Serigrafía o tampografía.

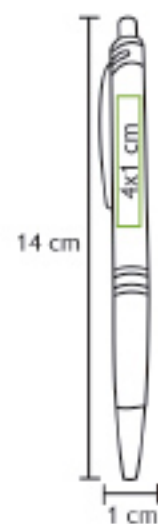

BL-29

Bolígrafo Stroller

Bolígrafo de plástico con marcador.

Colores: Azul, rosa, naranja, verde y amarillo.

Impresión: Serigrafía o tampografía.

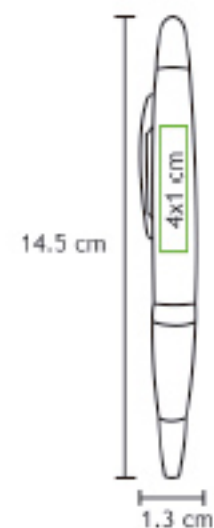

BL-30

Bolígrafo Cairo

Bolígrafo ecológico con accesorios de plástico translúcido.

Colores: Morado, azul, rojo, amarillo y verde.

Impresión: Serigrafía o tampografía.





BL-31

Llavero con 2 Bolígrafos

Juego de llavero de plástico con 2 bolígrafos.
Impresión: Serigrafía o tampografía.

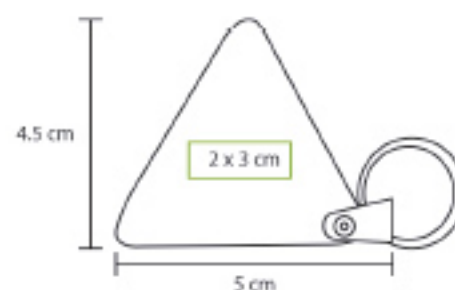

BL-33

Bolígrafo Alfa

Bolígrafo de plástico retráctil con grip.

Colores: Verde, amarillo, rojo, negro y azul.
Impresión: Serigrafía o tampografía.

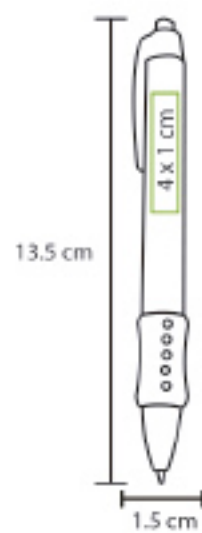

BL-34

Bolígrafo Mani

Bolígrafo de plástico retráctil.

Colores: Azul, negro, naranja, rojo y verde.

Impresión: Serigrafía o tampografía.

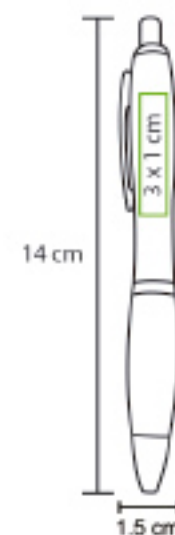

BL-35

Bolígrafo Delta

Bolígrafo de plástico retráctil con grip.

Colores: Negro, azul, naranja, verde y rojo.

Impresión: Serigrafía o tampografía.

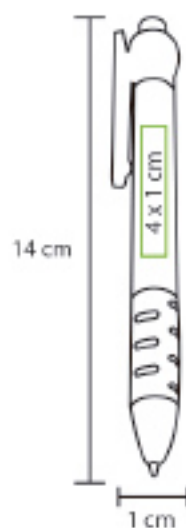

BOLÍGRAFOS



BL-36

Bolígrafo Lambda

Bolígrafo de plástico retráctil.
Colores: Verde, morado, azul y rojo.
Impresión: Serigrafía o tampografía.



BL-37

Bolígrafo Kappa

Bolígrafo de plástico translúcido retráctil.
Colores: Negro, amarillo, verde, naranja, rojo, blanco y azul.
Impresión: Serigrafía o tampografía.

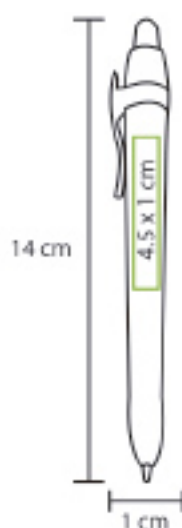

BL-38

Bolígrafo Evia

Bolígrafo de plástico retráctil.

Colores: Verde, naranja, azul, rojo y negro.

Impresión: Serigrafía o tampografía.

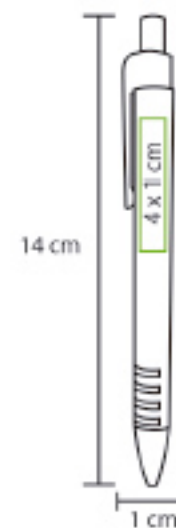

BL-39

Bolígrafo Tripoli

Bolígrafo de plástico retráctil.

Colores: Morado, verde, naranja, azul, rojo y negro.

Impresión: Serigrafía o tampografía.

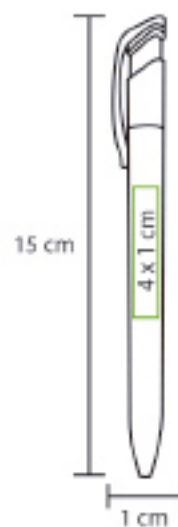

BOLÍGRAFOS



BL-41

Bolígrafo Beta

Bolígrafo de plástico retráctil con grip.

Colores: Azul, naranja, rojo, rosa, negro y verde.
Impresión: Serigrafía o tampografía.

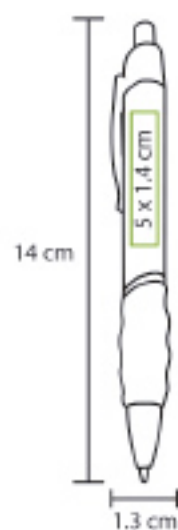

BL-40

Bolígrafo Duo

Bolígrafo de plástico con marca textos.

Colores: Negro, plata, azul y vino.
Impresión: Serigrafía o tampografía.



BL-42

Bolígrafo Lota

Bolígrafo de plástico retráctil con grip.
Colores: Rosa, verde, azul, negro y rojo.
Impresión: Serigrafía o tampografía.



BL-43

Bolígrafo Omega

Bolígrafo de plástico retráctil con grip.
Colores: Azul, negro, verde y rojo.
Impresión: Serigrafía o tampografía.

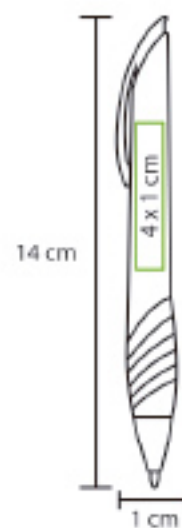

BOLÍGRAFOS

BL-44

Bolígrafo Esparta

Bolígrafo de plástico retráctil.
Colores: Azul, rojo, naranja, verde,
plata, morado, blanco y negro.
Impresión: Serigrafía o tampografía.

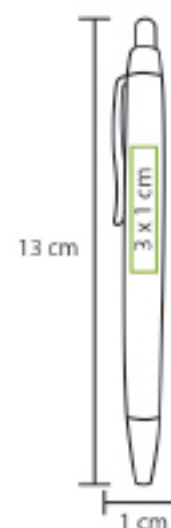

BL-45

Bolígrafo Argos

Bolígrafo de plástico retráctil con grip.
Colores: Naranja, negro, verde, blanco, rojo y azul.
Impresión: Serigrafía o tampografía.

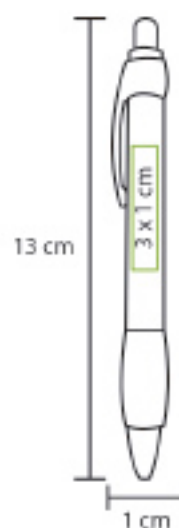

BL-46

Bolígrafo Gamma

Bolígrafo de plástico retráctil.
Colores: Verde, negro, rojo y azul.
Impresión: Serigrafía o tampografía.

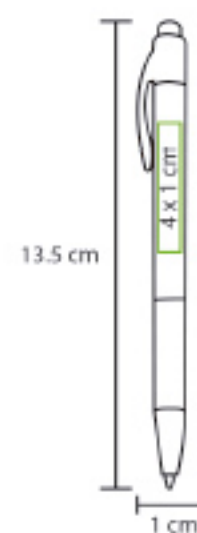

BL-47

Bolígrafo Sigma

Bolígrafo de plástico retráctil.
Colores: Azul, negro, verde, rojo y amarillo.
Impresión: Serigrafía o tampografía.

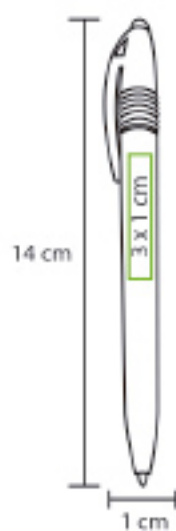

BOLÍGRAFOS



BL-48

Bolígrafo Kore

Bolígrafo de plástico retráctil.
Colores: Azul, rojo, naranja y negro.
Impresión: Serigrafía o tampografía.

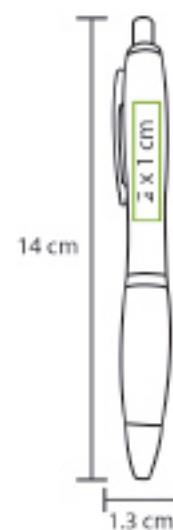

BL-49

Bolígrafo Ecológico

Bolígrafo ecológico con accesorios de plástico.

Colores: Verde, negro, azul y rojo.

Impresión: Serigrafía o tampografía.

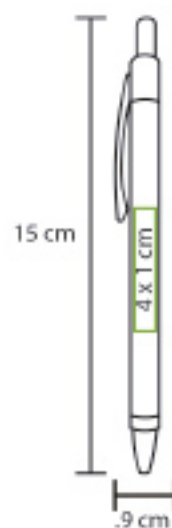

BL-50

Bolígrafo Atenas

Bolígrafo de plástico retráctil con grip.

Colores: Azul, negro y rojo.

Impresión: Serigrafía o tampografía.



BL-51

Bolígrafo Olimpia

Bolígrafo de plástico translúcido retráctil con grip.

Colores: Azul, negro, verde, rojo y amarillo.

Impresión: Serigrafía o tampografía.

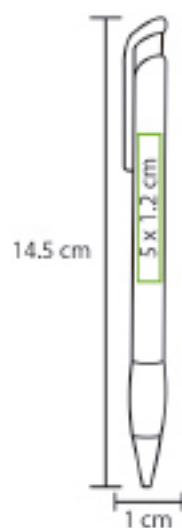

BOLÍGRAFOS



BL-53

Bolígrafo Zeta

Bolígrafo de plástico translúcido colgable.
Colores: Amarillo, rojo, blanco y azul.
Impresión: Serigrafía o tampografía.



BL-52

Bolígrafo Ypsilon

Bolígrafo de plástico translúcido twist.
Colores: Azul, rojo, blanco y negro.
Impresión: Serigrafía o tampografía.

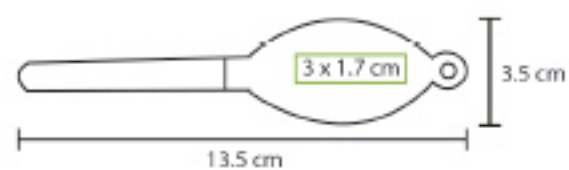
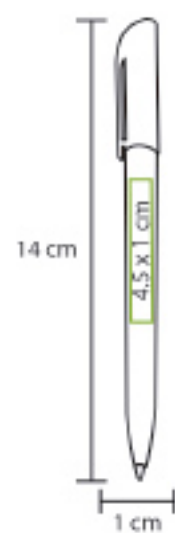

BL-54

Bolígrafo Tau

Bolígrafo de plástico retráctil con grip.

Colores: Azul, negro, blanco y rojo.

Impresión: Serigrafía o tampografía.

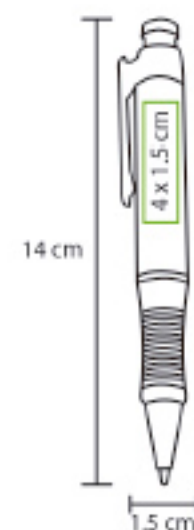

BL-55

Bolígrafo Omicron

Bolígrafo de plástico retráctil con grip.

Colores: Azul, negro, verde, rojo, blanco y naranja.

Impresión: Serigrafía o tampografía.

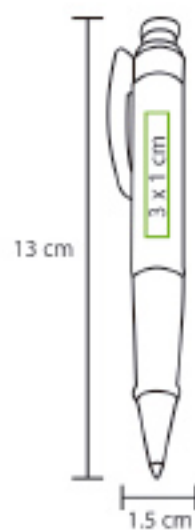

BOLÍGRAFOS



BL-56

Bolígrafo Creta

Bolígrafo de plástico.

Colores: Azul, rojo, plata, naranja y negro.

Impresión: Serigrafía o tampografía.

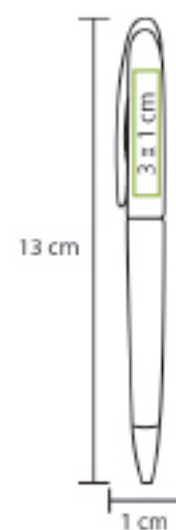

BL-57

Bolígrafo Andros

Bolígrafo de plástico retráctil.

Colores: Verde, naranja, azul, rojo y negro.

Impresión: Serigrafía o tampografía.

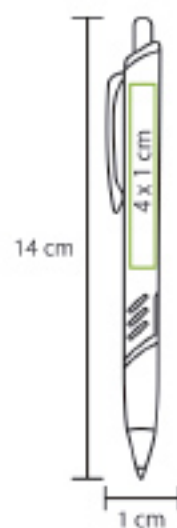

BL-58

Bolígrafo Itaca

Bolígrafo de plástico retráctil.

Colores: Azul, negro y rojo.

Impresión: Serigrafía o tampografía.

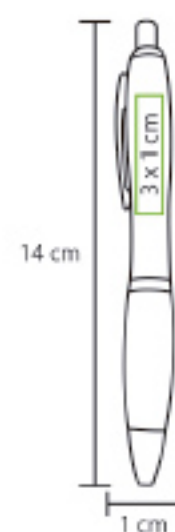

BL-59

Bolígrafo Kavala

Bolígrafo de plástico retráctil.

Colores: Azul, morado, rosa y naranja.

Impresión: Serigrafía o tampografía.

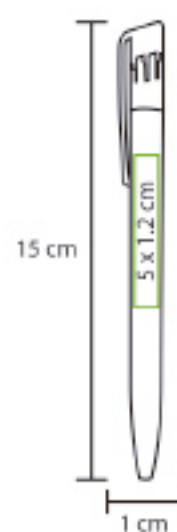

BOLÍGRAFOS



BL-60

Bolígrafo Master 2 en 1

Bolígrafo de plástico con marca textos.
Colores: Azul, naranja, amarillo y verde.
Impresión: Serigrafía o tampografía.

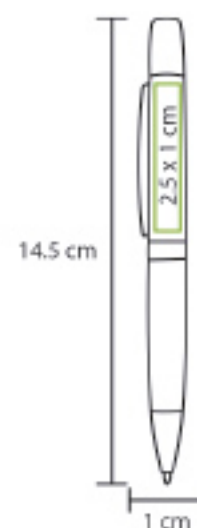

BL-61

Bolígrafo Alaska

Bolígrafo de plástico retráctil.
Colores: Negro, morado, azul, rojo,
amarillo, verde y naranja.
Impresión: Serigrafía o tampografía.

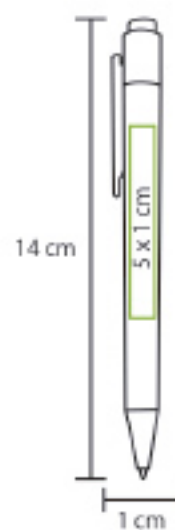

BL-62

Bolígrafo Arizona

Bolígrafo de plástico retráctil.
Colores: Azul, negro, blanco y rojo.
Impresión: Serigrafía o tampografía.

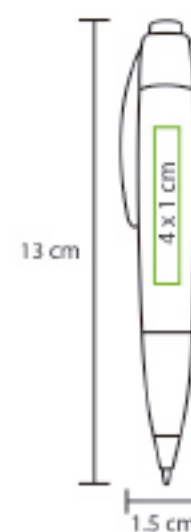

BL-63

Bolígrafo Eco Duo

Bolígrafo ecológico con marcatextos y tapón de plástico.
Colores: Rosa, morado, amarillo, azul, rojo y naranja.
Impresión: Serigrafía o tampografía.

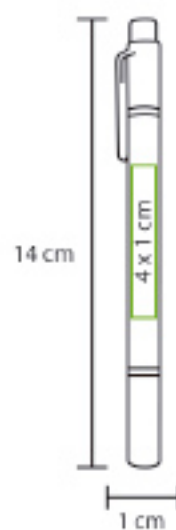

BOLÍGRAFOS



BL-65

Bolígrafo Florida

Bolígrafo de plástico retráctil.

Colores: Azul, verde, amarillo, negro y rojo.

Impresión: Serigrafía o tampografía.

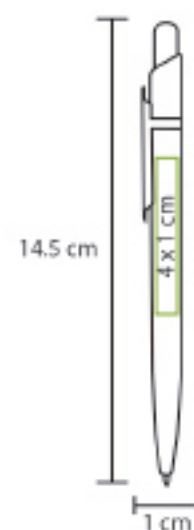

BL-66

Bolígrafo Kansas

Bolígrafo de plástico retráctil.

Colores: Negro, rojo, azul y verde.

Impresión: Serigrafía o tampografía.

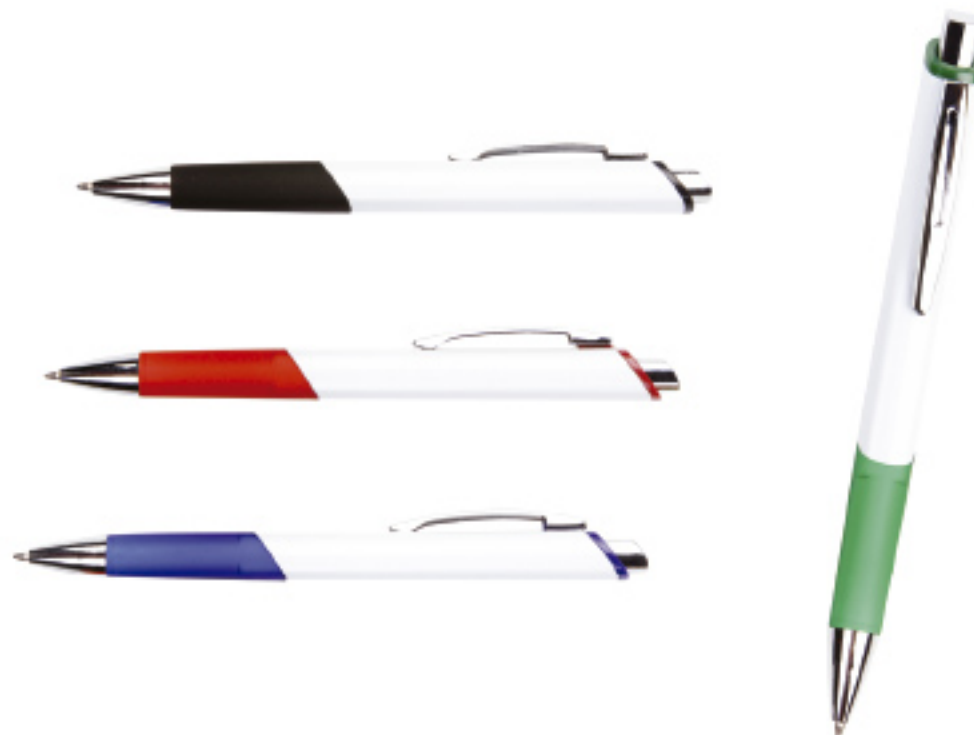
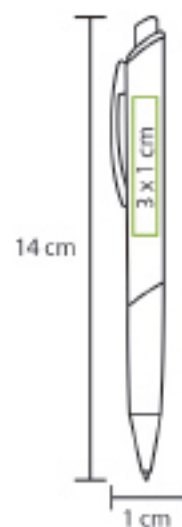

BL-67

Bolígrafo Jersey

Bolígrafo de plástico retráctil.
Colores: Verde, naranja, amarillo y rojo.
Impresión: Serigrafía o tampografía.

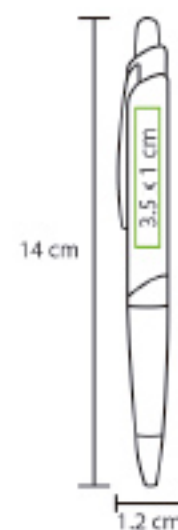

BL-69

Bolígrafo Basic

Bolígrafo económico de plástico con tapón.
Colores: Negro, blanco, azul y rojo.
Impresión: Serigrafía o tampografía.



BOLÍGRAFOS

BL-70

Bolígrafo Lanús

Bolígrafo metálico touch con grip.
Colores: Rojo, azul, morado, verde, plata y negro.
Impresión: Serigrafía o tampografía.

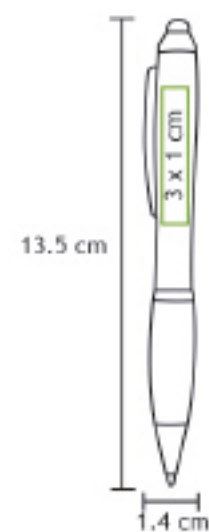

BL-71

Bolígrafo Rioja

Bolígrafo metálico touch con estuche.
Colores: Negro, rojo, rosa, azul y plata.
Impresión: Serigrafía o tampografía.

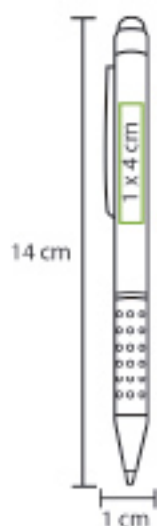

BL-72

Bolígrafo Montevideo

Bolígrafo metálico touch con lámpara.

Colores: Negro, azul y blanco.

Impresión: Serigrafía o tampografía.

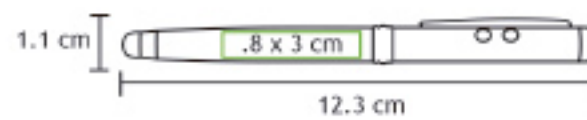

BL-73

Bolígrafo Valdibía

Bolígrafo de plástico con grip de plástico.

Colores: Rosa, rojo, verde, azul, amarillo y negro.

Impresión: Serigrafía o tampografía.

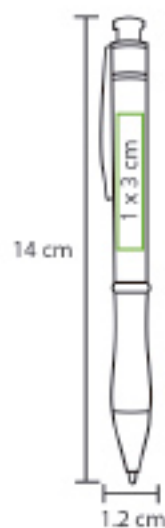

BOLÍGRAFOS



BL-75

Bolígrafo Porto

Bolígrafo touch con lámpara fabricado en material ABS.

Colores: Negro, rojo y azul.

Impresión: Serigrafía o tampografía.

BL-74

Bolígrafo Asunción

Bolígrafo touch con lámpara y grip.

Colores: Rojo, azul, negro y plata.

Impresión: Serigrafía o tampografía.



■■ ANTONIO MIRO ■■ **BL-76**

Bolígrafo Yago

Bolígrafo puntero metálico con estuche.

Impresión: Serigrafía o tampografía.



BL-68

Set de Escritura 5 en 1

Set de plástico con bolígrafos, lápiz y marca textos.

Colores: Rojo, azul y negro.

Impresión: Serigrafía o tampografía.



DK-33

Set Pekin

Juego de 4 marca textos de colores en estuche de plástico.

Impresión: Serigrafía o tampografía.

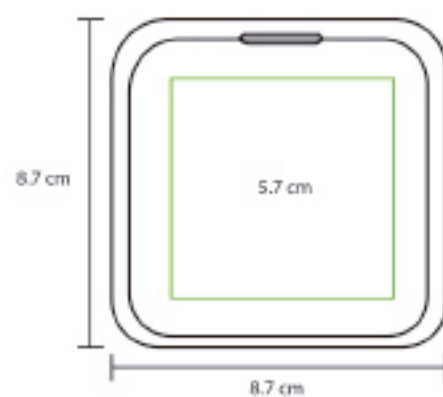

Set Vancouver

Juego de marca textos en estuche de plástico.
Impresión: Serigrafía o tampografía.

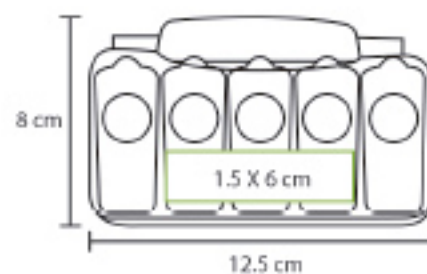

DK-40

Set Sidney

Figura de plástico con 5 marca textos de colores.
Impresión: Serigrafía o tampografía.

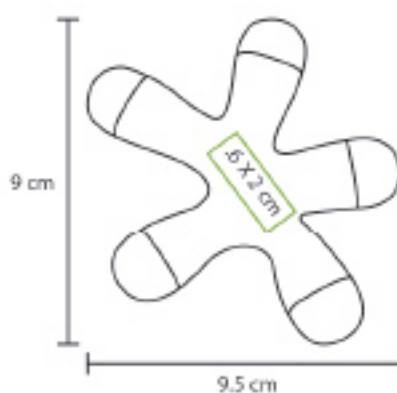

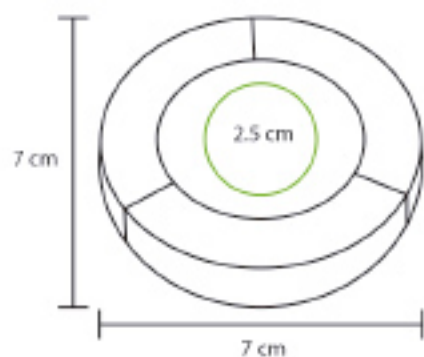

DK-44

Set Nevada

Figura de plástico circular con 3 marca textos de colores.
Impresión: Serigrafía o tampografía.

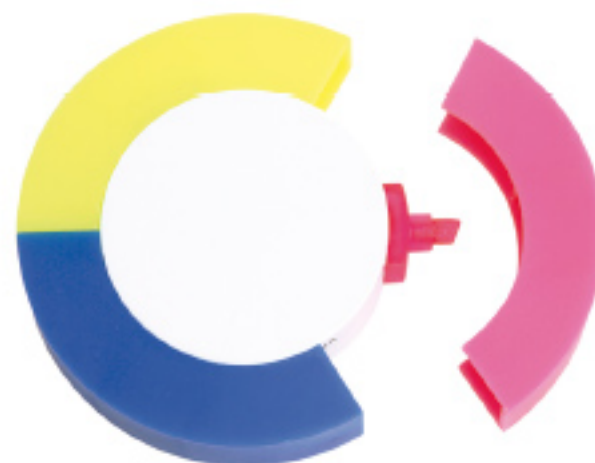

DK-45

Set Nebraska

Figura de plástico en forma de triángulo con 3 marca textos de colores.
Impresión: Serigrafía o tampografía.

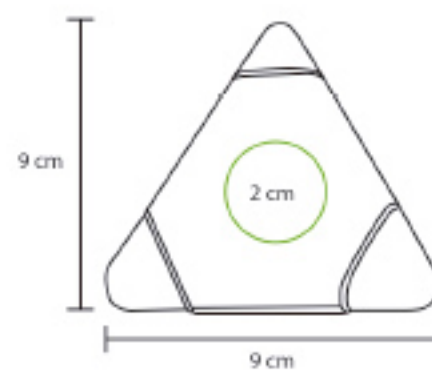



HERRAMIENTAS

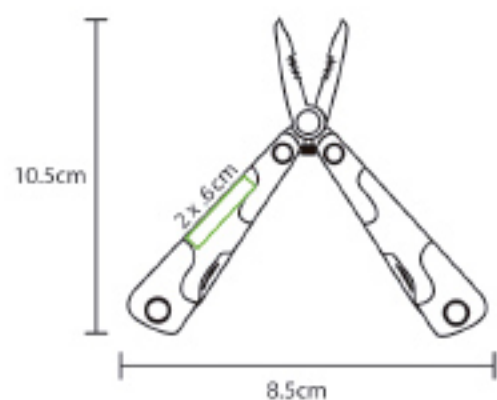

EX-13

Herramienta London

Pinza multiusos metálica con insertos de madera. Incluye estuche metálico. Impresión: Serigrafía o grabado láser.



EX-14

Herramienta York

Pinza multiusos metálica con aplicaciones en silicón negro. Incluye estuche metálico. Impresión: Serigrafía o grabado láser.

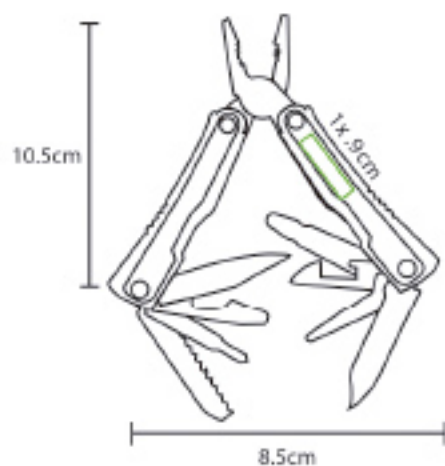



HE-01

Set Oxford

Set con navaja, brújula y lámpara.
Incluye estuche metálico.
Impresión: Serigrafía o grabado diamante.

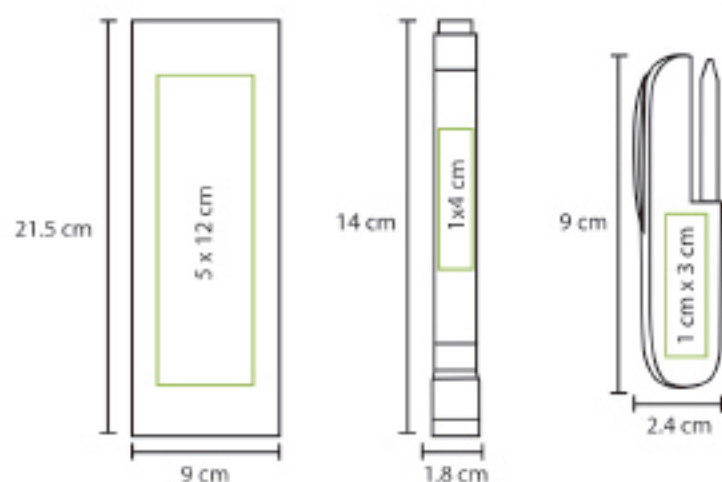

HE-02

Set Ginebra

Set con calibrador de presión de llantas, lámpara y pluma. Incluye estuche metálico.
Impresión: Serigrafía o grabado diamante.

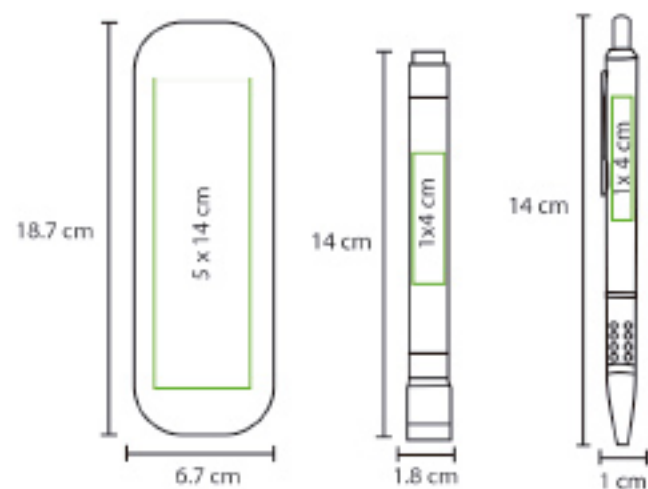

HE-03

Set Master Tools

Juego de desarmador con 9 puntas intercambiables fabricado en aluminio. Impresión: Serigrafía o grabado diamante.

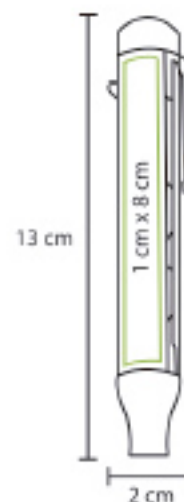

HE-04

Navaja Multiusos

Navaja metálica con 7 funciones. Incluye estuche. Impresión: Serigrafía, grabado láser o diamante.

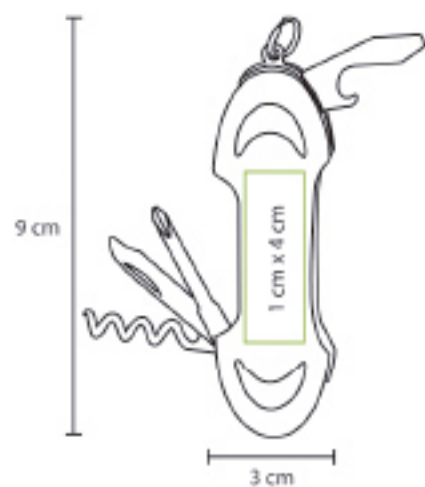

HE-05

Set Oslo

Set de navaja y lámpara. Incluye estuche metálico y baterías.
Impresión: Serigrafía, grabado láser o diamante.

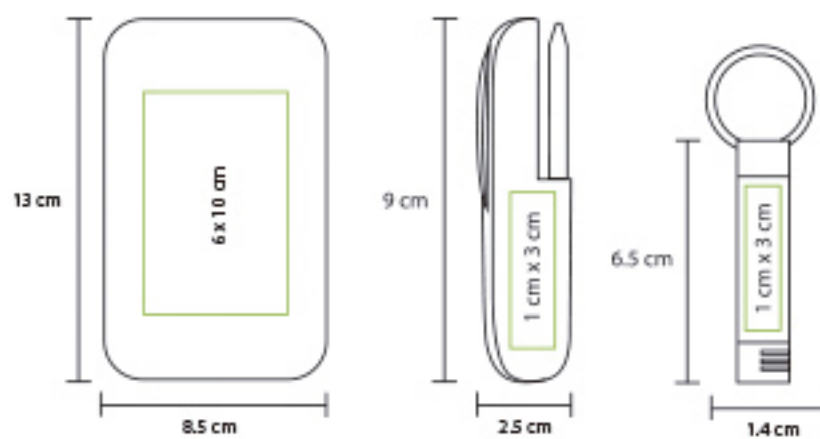

HE-09

Linterna

Linterna de aluminio con estuche metálico.
Incluye 2 baterías AAA y cordón.
Impresión: Serigrafía, grabado láser o diamante.

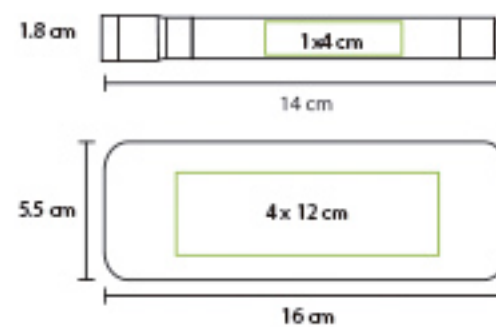

HERRAMIENTAS

HE-07

Set Mayorca

Set con navaja de 7 funciones y llavero de curpiel con metal.
Impresión: Grabado láser o diamante.

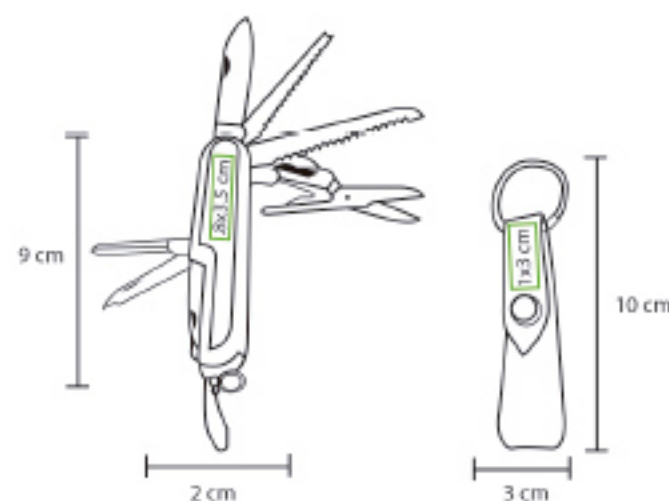

HE-08

Estuche Helsinki

Estuche de herramientas con 22 piezas.
Impresión: Serigrafía o grabado láser.

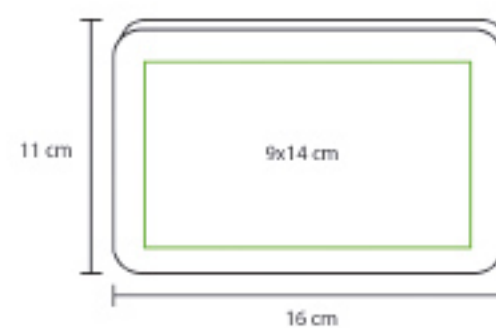

HE-10

Llavero Flexómetro

Llavero flexómetro ovalado de plástico.

Colores: Blanco, azul y rojo.

Impresión: Serigrafía o tampografía.



HE-11

Llavero flexómetro

Llavero flexómetro cuadrado de plástico.

Colores: Negro, azul, rojo y blanco.

Impresión: Serigrafía o tampografía.

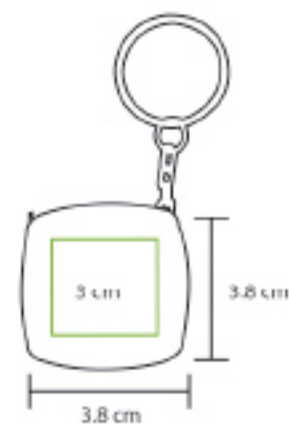

HE-12

Llavero 2 en 1

Llavero flexómetro de plástico con bolígrafo.

Colores: Rojo y azul.

Impresión: Serigrafía o tampografía.

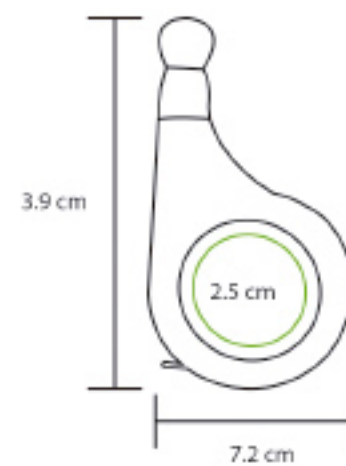

HE-13

Set de Herramientas

Estuche de herramientas con flexómetro y puntas de desarmador.

Colores: Negro, rojo, azul y blanco.

Impresión: Serigrafía o tampografía.

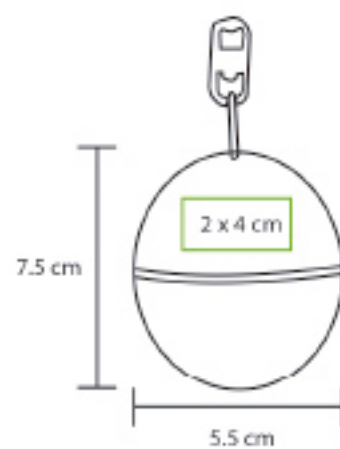

HE-14

Set Olympus

Set de desarmadores fabricado en metal con plástico translúcido.
Colores: Humo, azul y rojo.
Impresión: Serigrafía o tampografía.

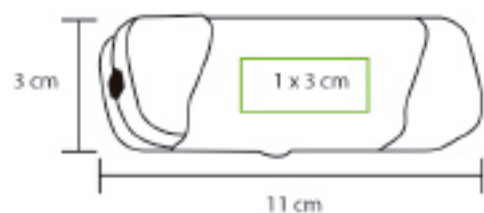

HE-15

Flexómetro Translúcido

Flexómetro de plástico translúcido con arnés.
Colores: Humo, azul y rojo.
Impresión: Serigrafía o tampografía.

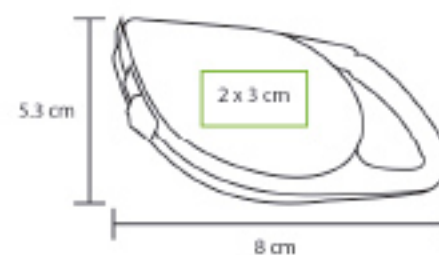

HE-16

Navaja 9 Funciones

Navaja metálica con 9 funciones
y estuche metálico.

Impresión: Tampografía, grabado láser o diamante.

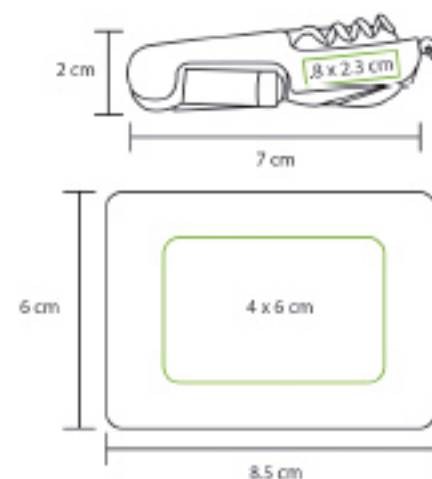

HE-17

Navaja 3 Funciones

Navaja de metal con 3 funciones.

Colores: Negro, vino, azul y plata.

Impresión: Serigrafía, grabado láser o diamante.



NUEVO



HE-18

Martillo Napoles

Martillo de acero inoxidable y cubierta de aluminio con 7 funciones. Incluye caja individual. Impresión: Serigrafía o tampografía.

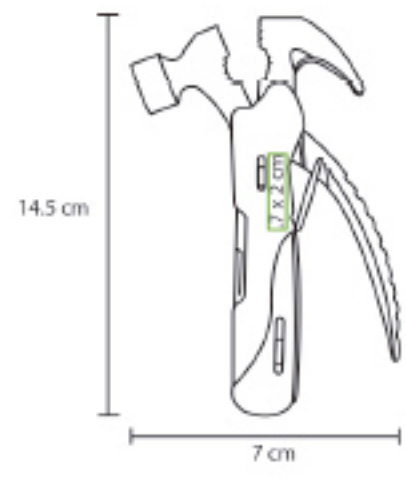

HE-19

Herramienta Benidorm

Pinza de acero inoxidable y cubierta de alumina. Con 9 funciones. Incluye estuche. Colores: Gris y rojo. Impresión: Tampografía o grabado láser.

NUEVO





HE-20

Navaja Valladolid

Navaja de acero inoxidable y cubierta de alumina con 10 funciones. Incluye estuche.

Colores: Verde y gris.

Impresión: Tampografía o grabado láser.

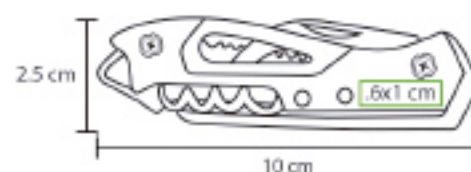

HE-21

Llavero Berlin

Llavero de acero inoxidable y cubierta de alumina con 4 funciones. Incluye caja.

Colores: Gris, naranja, azul y rojo.

Impresión: Tampografía o grabado láser.

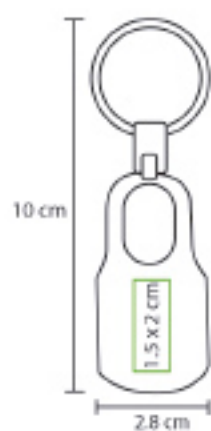

HE-23

Set Coruña

Set de desarmador con 4 puntas intercambiables, flexómetro y lámpara. Incluye caja.
Colores: Azul, negro y rojo.
Impresión: Serigrafía o tampografía.



HE-25

Set Lemans

Set de herramientas con 24 accesorios.
Impresión: Serigrafía o tampografía.

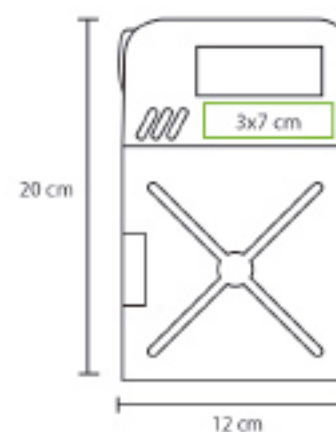



HE-24

Lámpara Granada

Lámpara de aluminio con luz led y correa.

Colores: Azul, morado, rojo y plata.

Impresión: Serigrafía o tampografía.





COCCINA Y HOGGAR





HM-04

Set de Tazas

Juego de 2 tazas fabricadas en acero inoxidable con mango de plástico y porta tazas.
Capacidad 190 ml.
Impresión: Serigrafía, grabado láser o diamante.

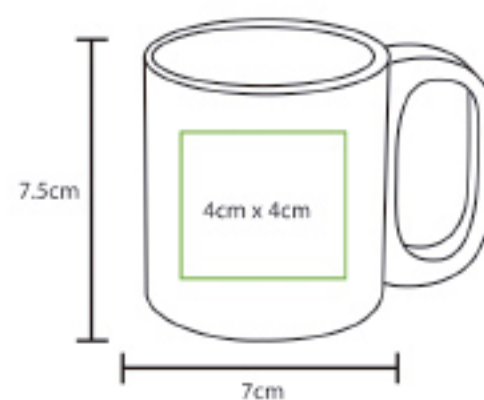

HM-09

Jarra Térmica

Jarra térmica fabricada en acero inoxidable con tapa dosificadora anti-derramante.
Capacidad de 1,200 ml.
Impresión: Serigrafía, grabado láser o diamante.





HM-10

Salad Dressing Set

Set de 4 recipientes fabricados en cristal con acero inoxidable.

Impresión: Serigrafía o grabado diamante.

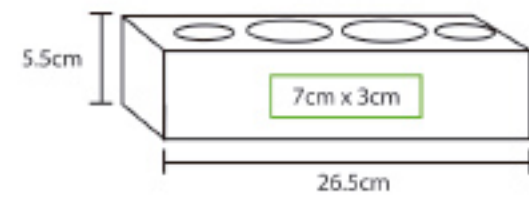

HM-14

Mandil

Mandil personal multiusos fabricado en material Non Woven.

Colores: Azul, rojo, blanco y negro.

Impresión: Serigrafía.

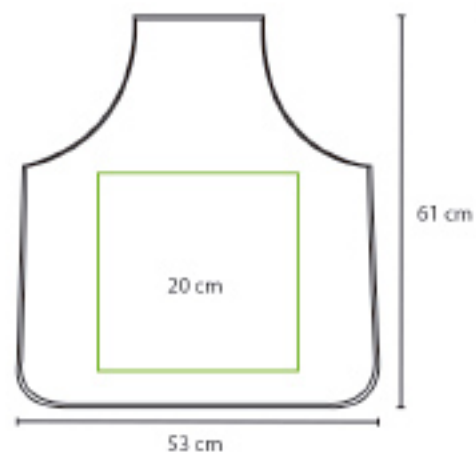

HM-18

Set de BBQ

Set BBQ de 4 piezas en acero inoxidable.

Incluye estuche de aluminio.

Impresión: Serigrafía, grabado láser o diamante.

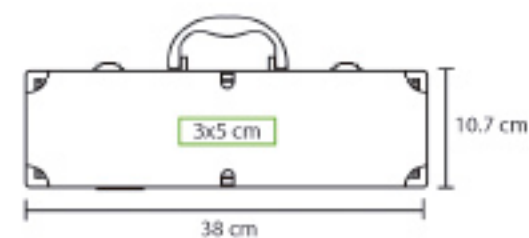

HM-20

Set de Cuchillos

Set de 6 cuchillos de acero inoxidable.

Incluye estuche en MDF.

Impresión: Serigrafía, tampografía o grabado láser.



HM-19

Charola Torino

Charola fabricada en material PS.

Colores: Azul, negro y rojo.

Impresión: Serigrafía.

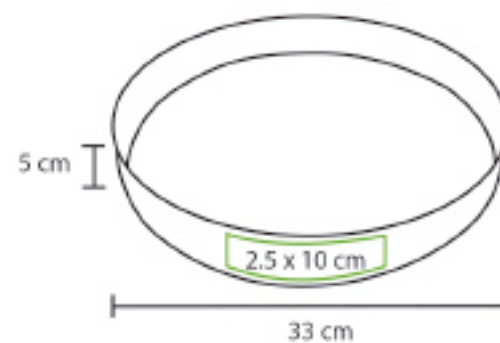



LIBRETAS

Libreta Escolar

Libreta con cubierta de plástico y estuche con cierre.

Colores: Verde, humo, rojo y azul.

No incluye accesorios.

Impresión: Serigrafía o tampografía.

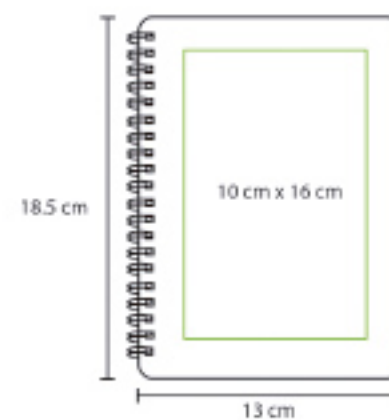

LB-02

Libreta Milán

Libreta biodegradable con pluma.
Colores: Negro, rojo, azul, amarillo, naranja y verde.
Impresión: Serigrafía o tampografía.

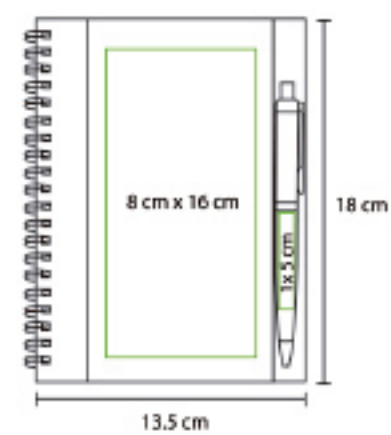

Libreta Marsella

Libreta biodegradable pocket con pluma.
Colores: Negro, rojo, verde, amarillo y azul.
Impresión: Serigrafía o tampografía.

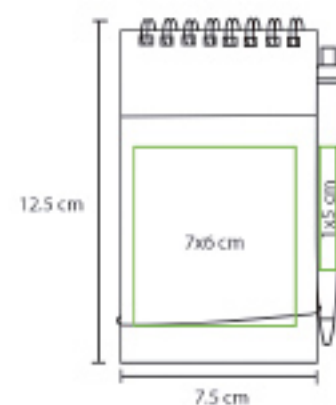

LB-04

Libreta Mónaco

Libreta rígida de cartón en color negro,
con pluma y notas adhesivas.

Color interior: Rojo y azul.

Impresión: Serigrafía o tampografía.

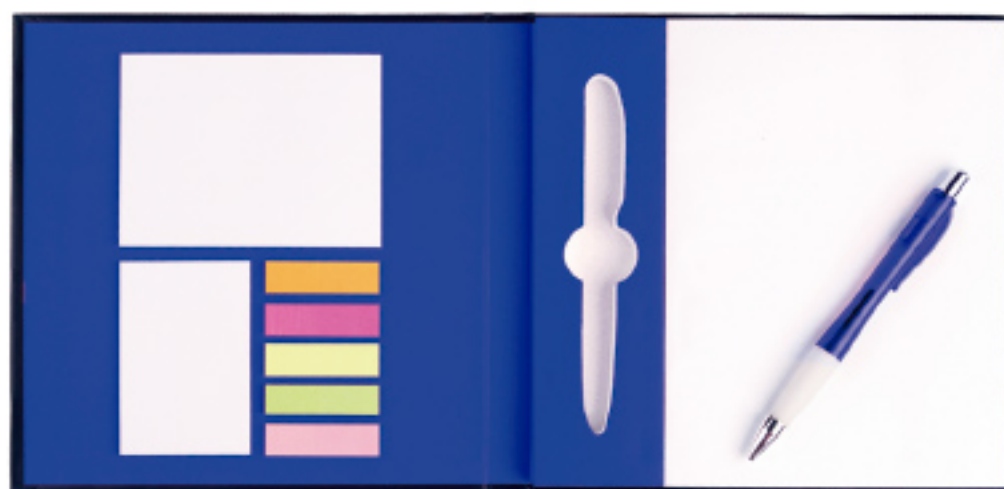
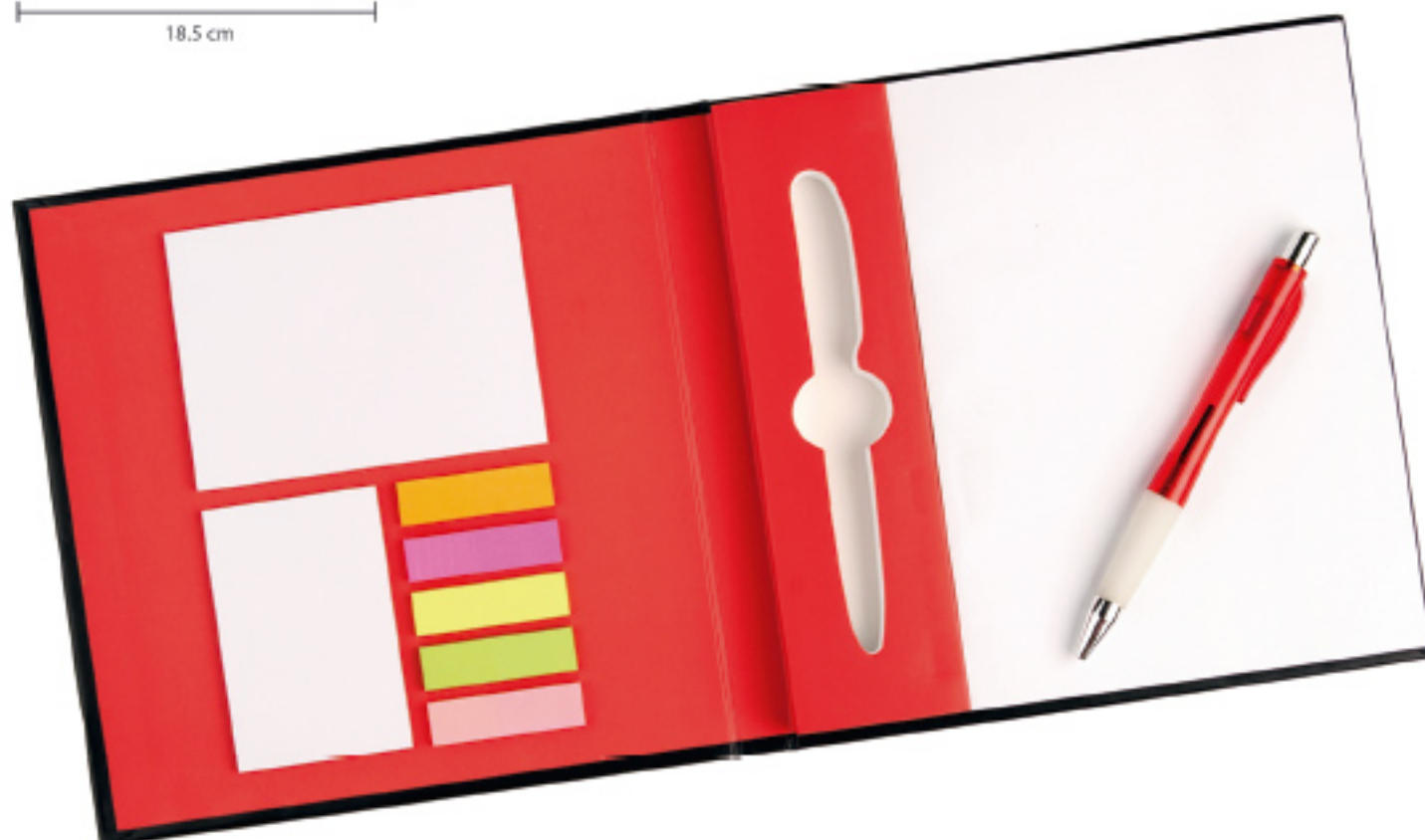
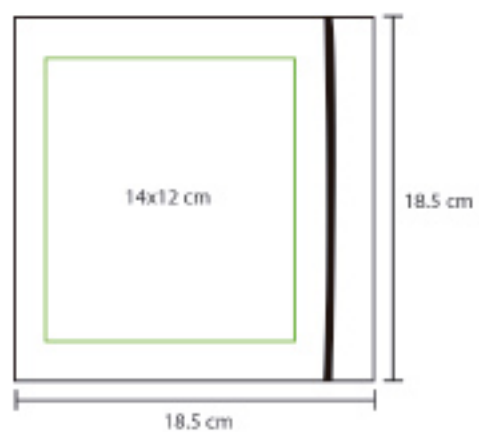

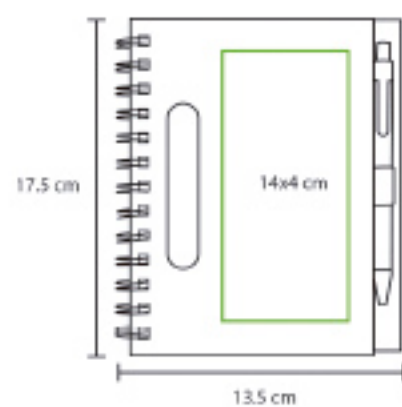

LB-05

Libreta Sydney

Libreta ecológica negra con pluma.
Colores: Verde, azul, naranja y rojo.
Impresión: Serigrafía o tampografía.



LB-06

Libreta Berlín

Libreta biodegradable con logo de recicla.

Colores: Rojo, negro, azul y naranja.

Impresión: Serigrafía o tampografía.

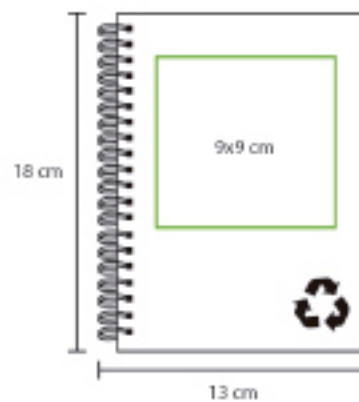

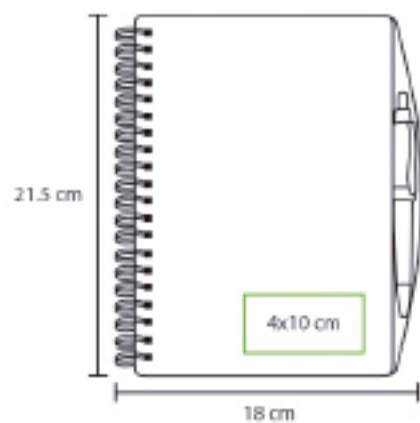

LB-07

Libreta Praga

Libreta de plástico rígido con pluma.

Colores: Humo, blanco, azul y rojo.

Impresión: Serigrafía o tampografía.





LB-08

Kit Ecológico

Cartera con notas adhesivas y pluma.
Impresión: Serigrafía.

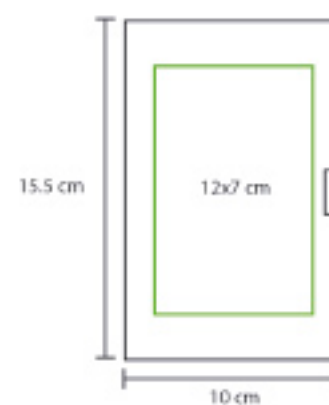

LB-09

Mini Libreta

Libreta mini portátil con cubierta de plástico.

Colores: Rojo, negro, amarillo, azul, rosa, verde y naranja.

Impresión: Serigrafía.

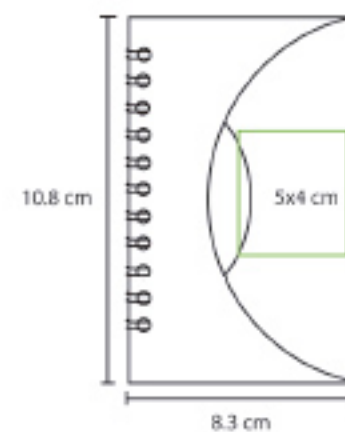

LIBRETAS

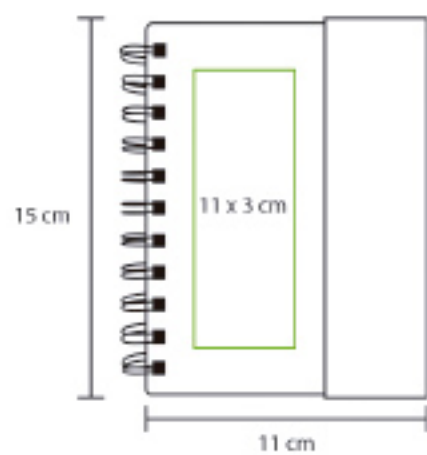

LB-10

Libreta Génova

Libreta ecológica con bolígrafo y notas adhesivas.

Colores: Negro, rojo, verde y azul.

Impresión: Serigrafía.



LB-11

Libreta Bolonia

Libreta ecológica con pluma.
Colores: Verde, azul, naranja, negro y rojo.
Impresión: Serigrafía.

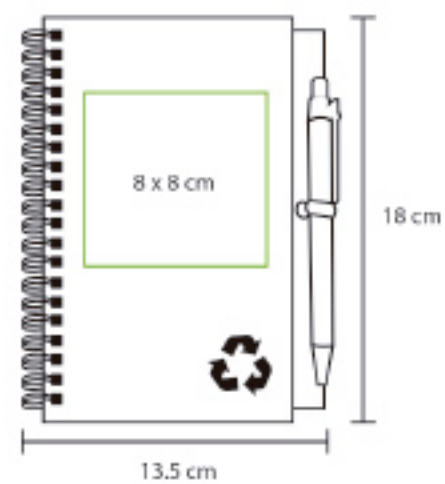



LB-12

Libreta Florencia

Libreta ecológica con bolígrafo.

Colores: Rojo, negro, azul, verde y naranja.

Impresión: Serigrafía.

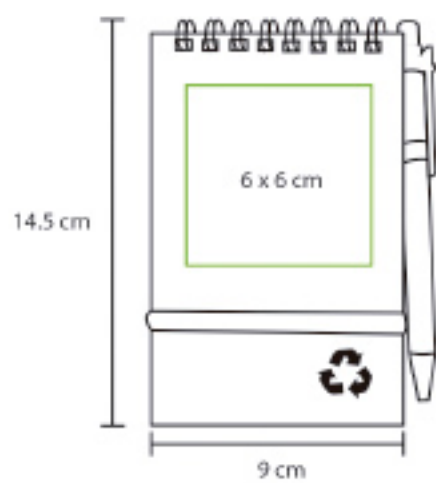

LB-13

Libreta Wire-o

Libreta de notas de plástico
con pluma y wire-o.

Colores: Humo, azul, blanco, rojo y rosa.

Impresión: Serigrafía.

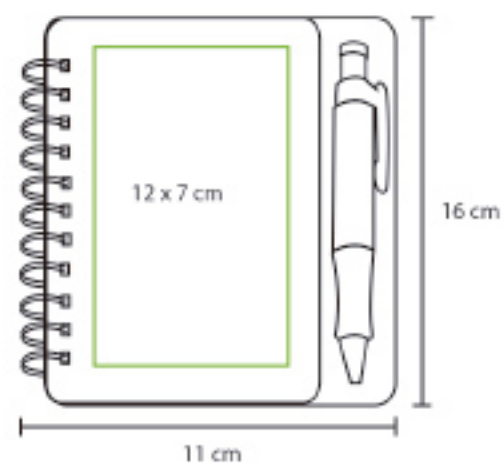

LB-14

Libreta con Pluma

Libreta de notas con pluma fabricada en plástico.

Colores: Rojo, azul y humo.

Impresión: Serigrafía.

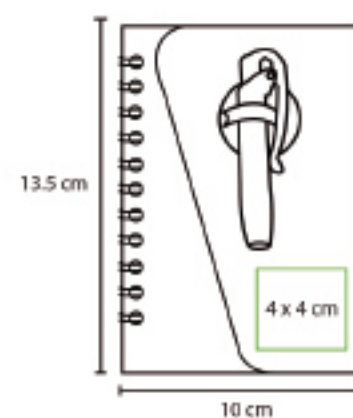

LB-15

Libreta con Imán

Libreta de plástico con imán para refrigerador.

Colores: Rojo, azul y humo.

Impresión: Serigrafía.

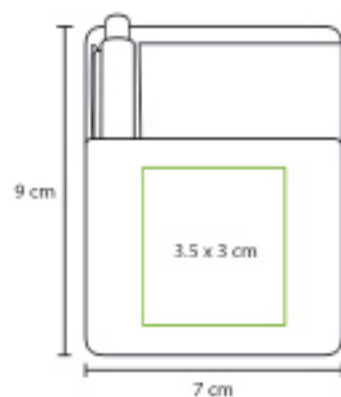

LB-16

Libreta Rígida

Libreta de notas rígida con pluma, fabricada en plástico

Colores: Azul, blanco y rojo.

Impresión: Serigrafía.

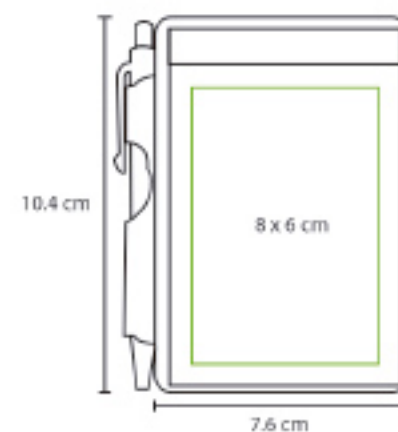

LB-17

Libreta con Calculadora

Libreta con calculadora y pluma fabricada en curpiel.

Colores: Azul, negro y rojo.

Impresión: Serigrafía.

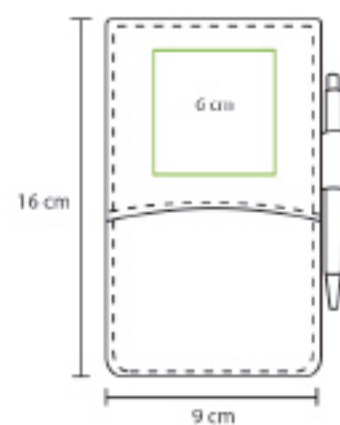

LB-18

Libreta Pamplona

Mini libreta ecológica con notas adhesivas y bolígrafo,
fabricado en cartón y papel reciclado.

Colores: Negro, blanco y cartón.
Impresión: Serigrafía.

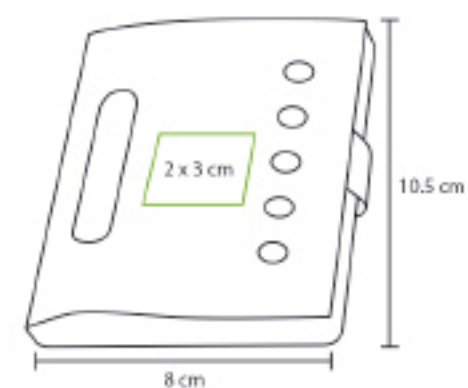



LLAVEROS

LL-01

Llavero Destapador

Llavero metálico rectangular con destapador. Incluye caja.
Impresión: Serigrafía, grabado láser o diamante.

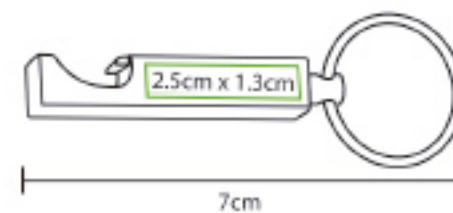

LL-02

Llavero Piel

Llavero de piel color negro con metal y argollas. Incluye caja.
Impresión: Serigrafía, grabado láser o diamante.

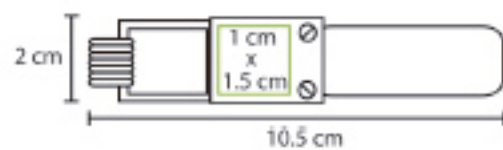

LL-03

Llavero Ovalado

Llavero metálico ovalado bi-tono. Incluye caja.
Impresión: Serigrafía, grabado láser o diamante.

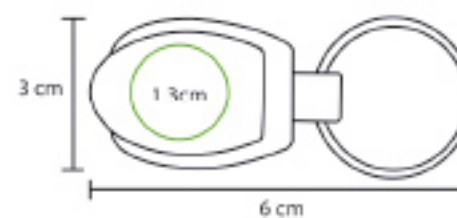

LL-04

Llavero Candado

Llavero metálico tipo candado.

Incluye caja.

Impresión: Serigrafía, grabado láser o diamante.

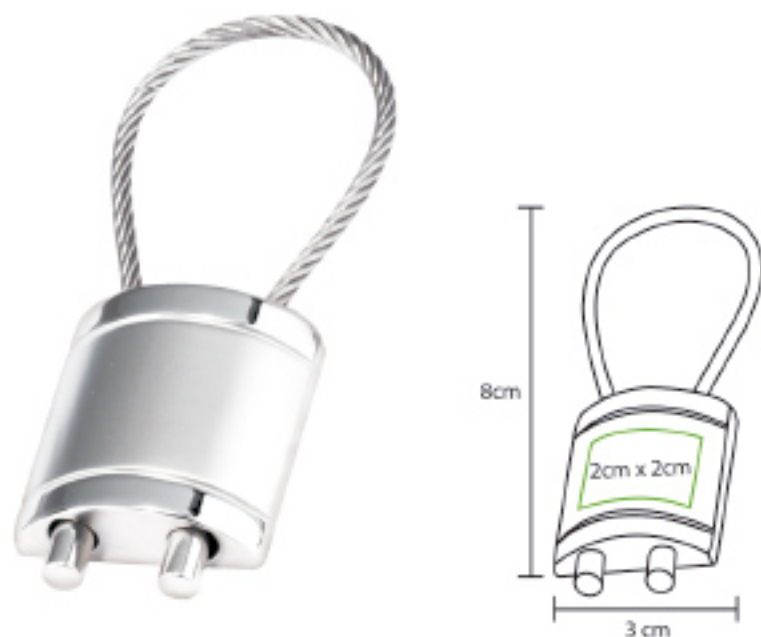

LL-05

Llavero Rectangular

Llavero metálico rectangular con argolla

tipo cadena. Incluye caja.

Impresión: Serigrafía, grabado láser o diamante.



LL-06

Llavero Escudo

Llavero metálico tipo escudo.

Incluye caja.

Impresión: Serigrafía, grabado láser o diamante.

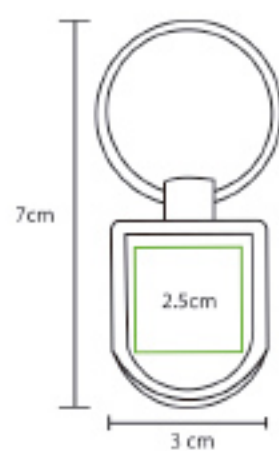

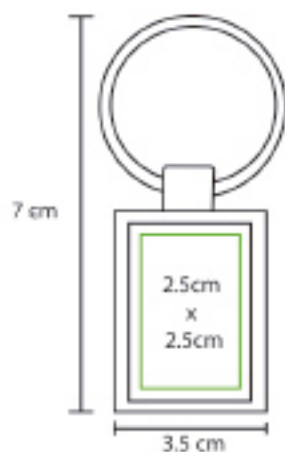

LL-07

Llavero Rectangular

Llavero metálico rectangular.

Incluye caja.

Impresión: Serigrafía, grabado láser o diamante.

LL-08

Llavero Casa-Coche

Llavero metálico doble. Incluye caja.

Impresión: Grabado láser o diamante.

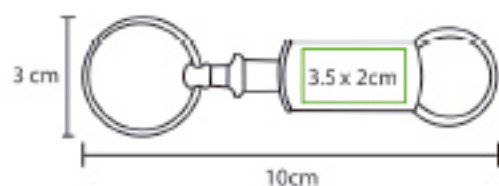

LL-09

Llavero 3 Argollas

Llavero metálico multi-argolla. Incluye caja.

Impresión: Grabado láser o diamante.

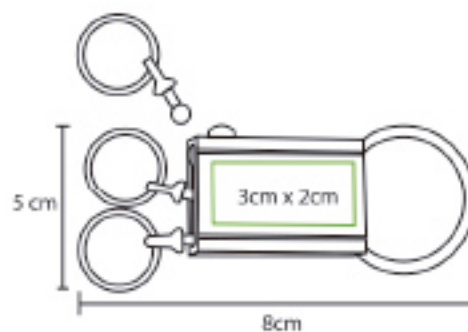

LL-10

Llavero con Luz

Llavero metálico con lámpara de luz led y argolla tipo arnés. Incluye baterías y estuche.
Impresión: Serigrafía, grabado láser o diamante.



LL-11

Llavero Doble Argolla

Llavero metálico con piel y doble argolla.
Incluye caja.

Colores: Rojo, azul, negro, café y rosa.

Impresión: Serigrafía, grabado láser o diamante.

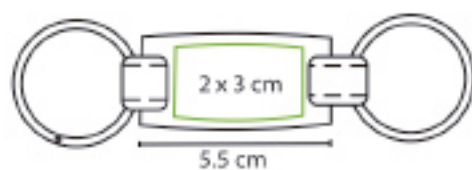

LLAVEROS



LL-12

Llavero Ekko

Llavero de plástico suave y argolla metálica.
Colores: Amarillo, azul, rojo, blanco,
verde y naranja.
Impresión: Serigrafía o tampografía.

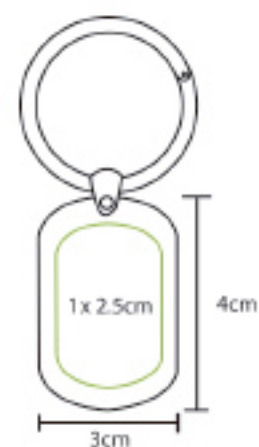

LL-13

Llavero Rectangular

Llavero metálico con tela. Incluye caja.

Colores: Amarillo, naranja, verde, negro, rojo y azul.

Impresión: Serigrafía, grabado láser o gota de resina.

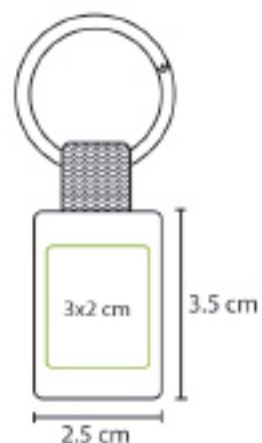

LL-14

Llavero Redondo

Llavero redondo metálico con tela. Incluye caja.
Colores: Azul, verde, naranja, amarillo, negro y rojo.
Impresión: Serigrafía, grabado láser o gota de resina.

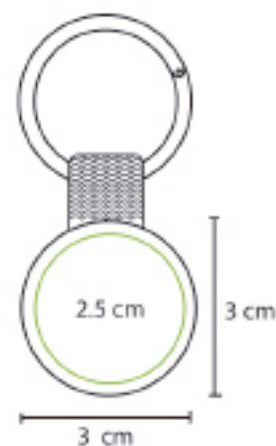

LL-15

Llavero Dúo

Llavero metálico con piel desprendible. Incluye caja.
Color blanco con negro.
Impresión: Grabado láser o diamante.



Llavero Niño

Llavero metálico en forma de niño.
Impresión: Serigrafía, grabado láser o diamante.

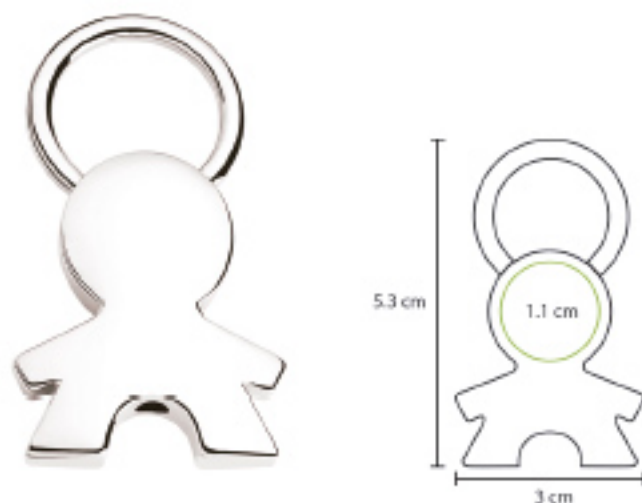

LL-17

Llavero Niña

Llavero metálico en forma de niña.
Impresión: Serigrafía, grabado láser o diamante.



LL-18

Llavero Casa

Llavero metálico en forma de casa.
Impresión: Serigrafía, grabado láser o diamante.

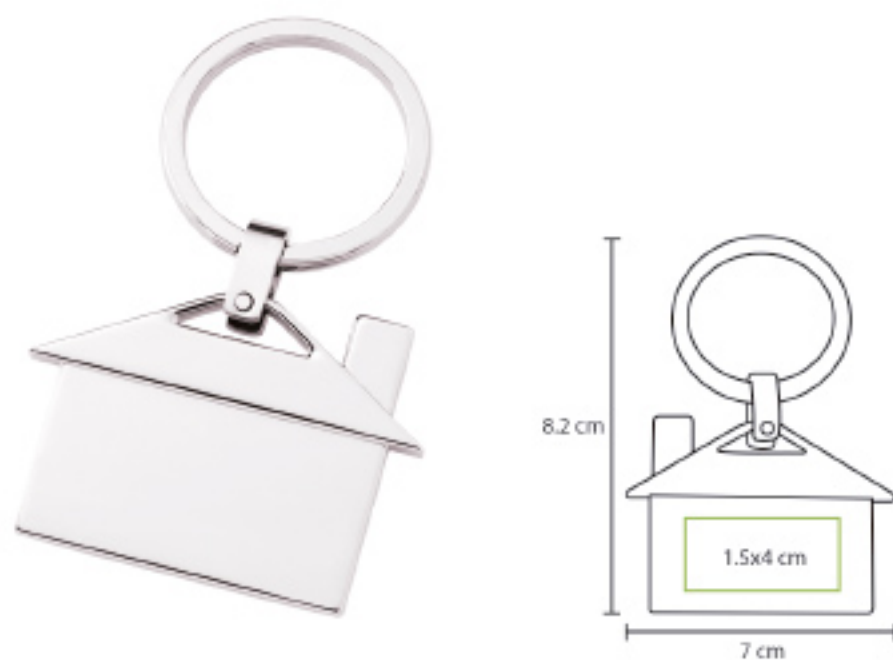

LL-19

Llavero Sky

Llavero metálico en forma de avión. Incluye caja.
Impresión: Tampografía, grabado láser o diamante.



LL-20

Llavero con Arnés

Llavero metálico con lámpara y arnés.
Colores: Azul, plata, rojo y negro.
Impresión: Tampografía, grabado láser o diamante.

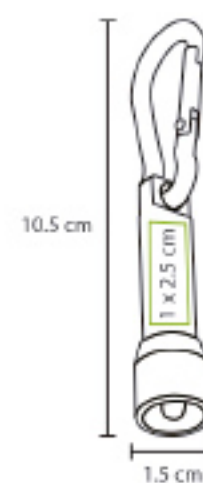

LLAVEROS

LL-21

Llavero Escudo

Llavero metálico en forma de escudo.
Impresión: Serigrafía, grabado láser o diamante.



LL-22

Llavero Redondo

Llavero metálico redondo.
Impresión: Serigrafía, grabado láser o diamante.

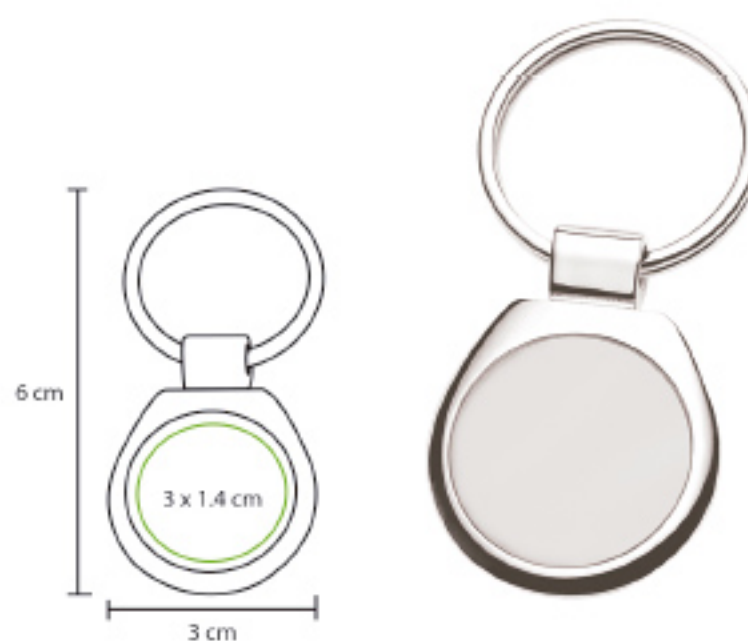

LL-23

Llavero Escudo

Llavero metálico tipo escudo.
Colores: Negro, rojo y azul
Impresión: Serigrafía, grabado láser o diamante.



LL-24

Llavero con Luz

Llavero de plástico con luz led.
Colores: Azul, naranja, verde, rosa y rojo.
Impresión: Serigrafía o tampografía.

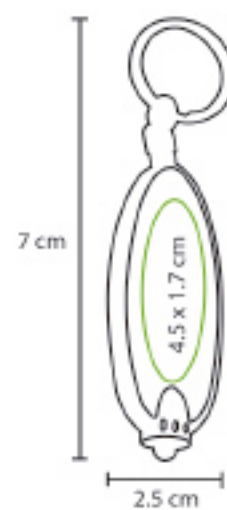

LL-25

Llavero Escudo

Llavero metálico de escudo.
Impresión: Serigrafía, grabado láser o diamante.

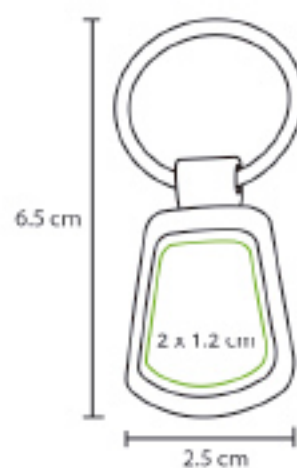

LLAVEROS

LL-26

Llavero Linterna

Llavero metálico con luz led.
Impresión: Grabado láser o diamante.



BL-31

Llavero con 2 Bolígrafos

Juego de llavero de plástico con 2 bolígrafos.
Impresión: Serigrafía o tampografía.

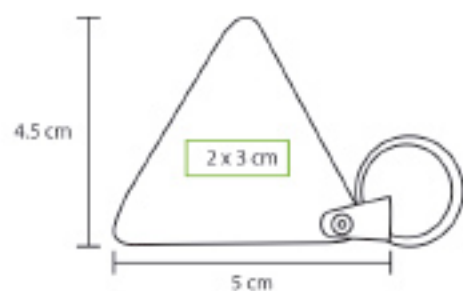

HM-13

Llavero Destapador

Llavero metálico con destapador.
Colores: Plata, azul, rojo y negro.
Impresión: Serigrafía o grabado láser.



LL-27

Llavero Grip

Llavero de plástico con gancho.
Colores: Azul, naranja, verde, negro y rojo.
Impresión: Serigrafía o tampografía.



LL-28

Llavero Redondo

Llavero redondo de metal y piel.
Impresión: Serigrafía, grabado láser o diamante.

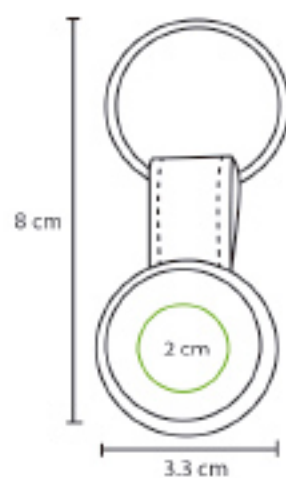



MAGENTA PROMOS



BL-12

Bolígrafo Celica

Bolígrafo metálico twist. Incluye estuche.
Impresión: Serigrafía o grabado láser.

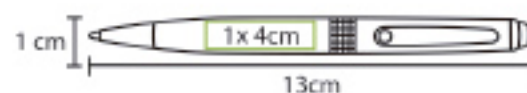

BL-17

Bolígrafo Thai

Bolígrafo de plástico retráctil.
Impresión: Serigrafía o tampografía.



BL-21

Bolígrafo Sevilla

Bolígrafo de plástico.
Impresión: Serigrafía o tampografía.

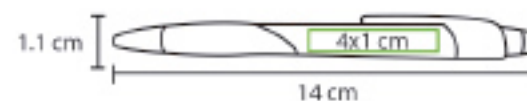

BL-29

Bolígrafo Seoul

Bolígrafo de plástico con marcador.
Impresión: Serigrafía o tampografía.



BL-41

Bolígrafo Beta

Bolígrafo de plástico retráctil con grip.
Impresión: Serigrafía o tampografía.



BL-42

Bolígrafo Lota

Bolígrafo de plástico retráctil con grip.
Impresión: Serigrafía o tampografía.

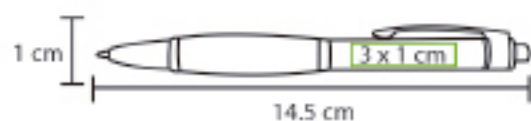

BL-59

Bolígrafo Kavala

Bolígrafo de plástico retráctil.
Impresión: Serigrafía o tampografía.

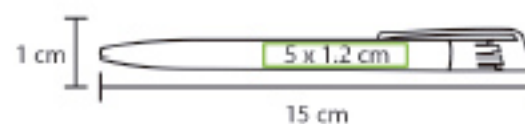

BL-63

Bolígrafo Eco Duo

Bolígrafo ecológico con marcatextos
y tapón de plástico.
Impresión: Serigrafía o tampografía.

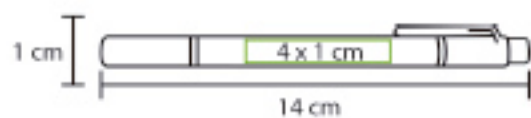

BL-67

Bolígrafo Jersey

Bolígrafo de plástico retráctil.
Impresión: Serigrafía o tampografía.

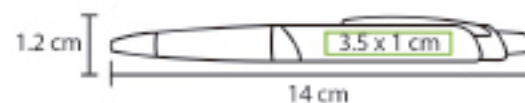

BL-73

Bolígrafo Valdibía

Bolígrafo de plástico con grip de plástico.
Impresión: Serigrafía o tampografía.

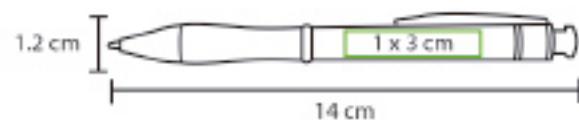

BE-09

Set de Manicure 4 Piezas

Set de manicure en estuche de plástico.
Impresión: Serigrafía o tampografía.

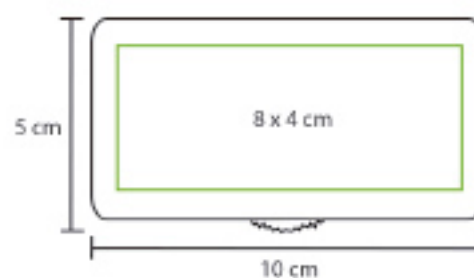

DK-24

Portaretrato Rompecabezas

Portaretrato para fotografía de 9cm x 13cm,
incluye caja de cartón.
Impresión: Serigrafía.

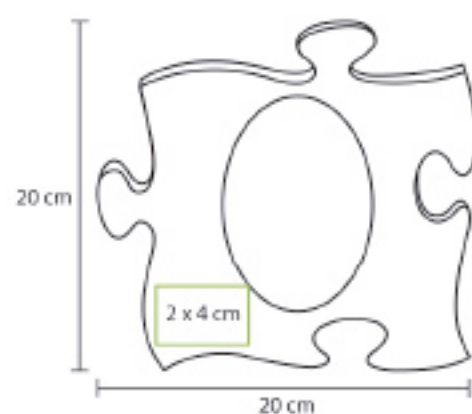



DK-52

Porta Gafete

Porta gafete retráctil de plástico.
Impresión: Serigrafía o goteado.

EX-31

Identificador de Maletas

Identificador de maletas con sujetador,
fabricado en plástico.
Impresión: Serigrafía o tampografía.



KD-06

Alcancia Nuovo

Alcancia de plástico con ventana al frente.
Impresión: Tampografía.

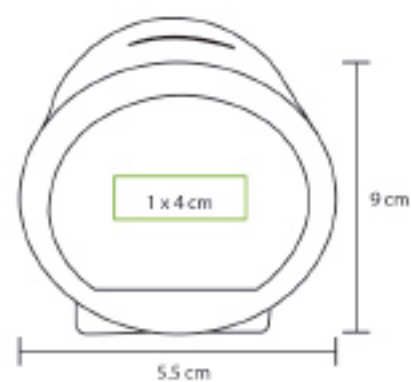

KD-09

Alcancia de Cerdito

Alcancia en forma de cerdito fabricada en PVC.
Impresión: Tampografía.

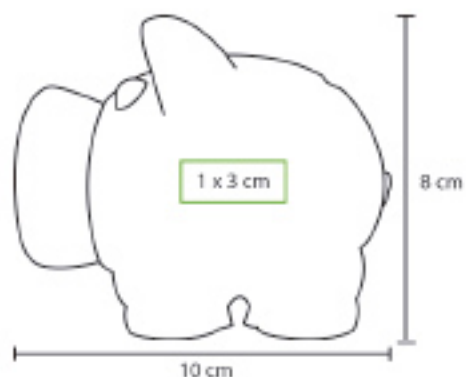

LB-09

Mini Libreta

Libreta mini portatil con cubierta de plástico.
Impresión: Serigrafía.

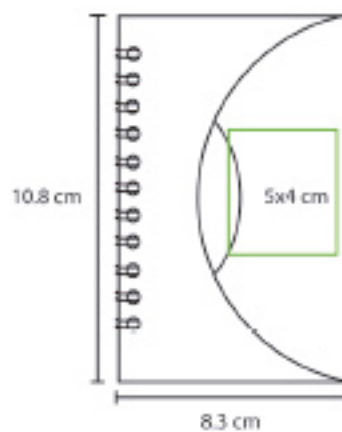

MP-02

Clip con Imán

Clip porta papeles con imán fabricado en PVC.
Impresión: Serigrafía o tampografía.

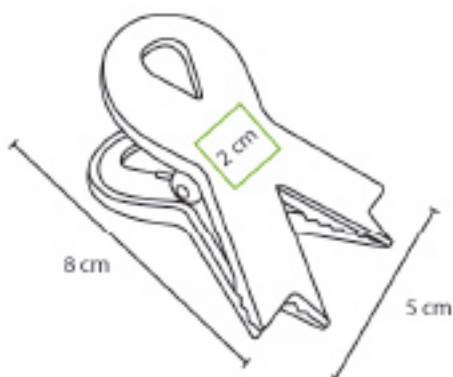

LL-11

Llavero Doble Argolla

Llavero metálico con piel y doble argolla.

Incluye caja.

Impresión: Serigrafía, grabado láser o diamante.

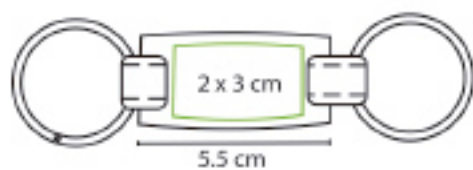

LL-24

Llavero con Luz

Llavero de plástico con luz led.

Impresión: Serigrafía o tampografía.

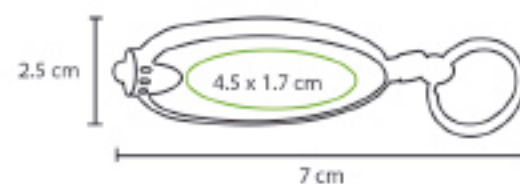

LB-13

Libreta Wire-o

Libreta de notas de plástico

con pluma y wire-o.

Impresión: Serigrafía.

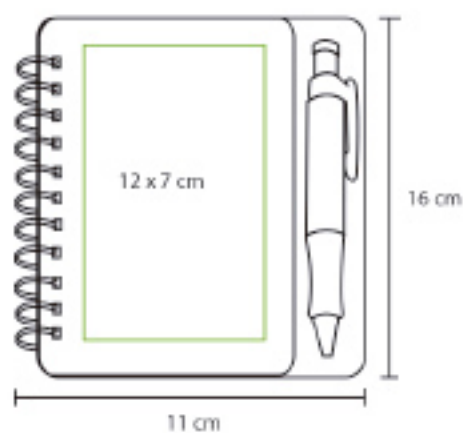

RP-43

Reloj de Pulso

Reloj de brazaletes flexible. No incluye estuche.
Impresión: Digital.

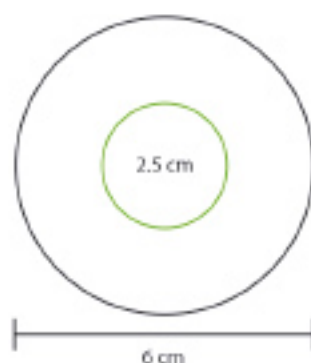

SB-11

Pelota Antiestrés

Pelota antiestrés lisa, fabricada en poliuretano.
Impresión: Tampografía.

TE-10

Cilindro de Policarbonato

Cilindro con tapa de aluminio,
con capacidad de 650 ml.
Impresión: Serigrafía o tampografía.

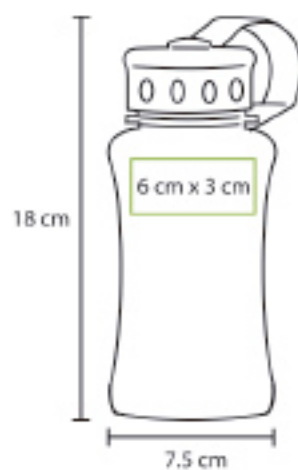

RP-44

Reloj de Pulso

Reloj fabricado en silicón. Incluye estuche.
Impresión: Serigrafía o tampografía.



SB-13

Puerco Antiestrés

Figura de puerco antiestrés, fabricada en poliuretano.
Impresión: Tampografía.

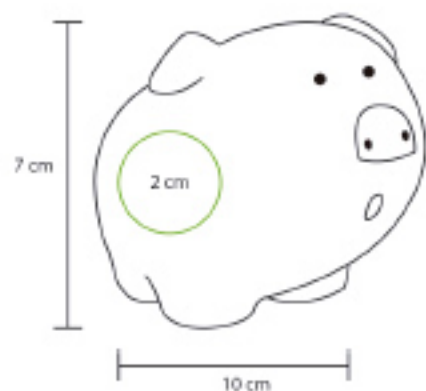

TH-26

Auricular Plex

Auricular y micrófono, mejora la calidad de las llamadas permitiendo el acceso a las demás funciones de su móvil mientras habla, conexión jack 3,5 mm.
Colores: Negro, azul, rojo, rosa y blanco.
Impresión: Serigrafía o tampografía.



TE-11

Cilindro Altea

Cilindro fabricado en policarbonato con tapa de aluminio, capacidad de 650 ml.
Impresión: Serigrafía o tampografía.

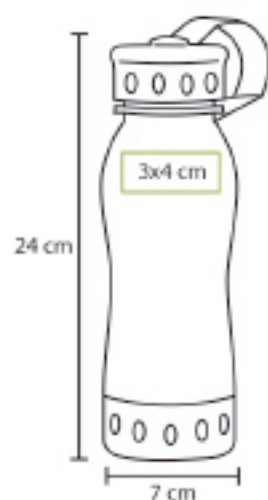

TE-16

Cilindro Toledo

Cilindro fabricado en policarbonato con tapa de aluminio, capacidad de 600 ml.
Impresión: Serigrafía o tampografía.

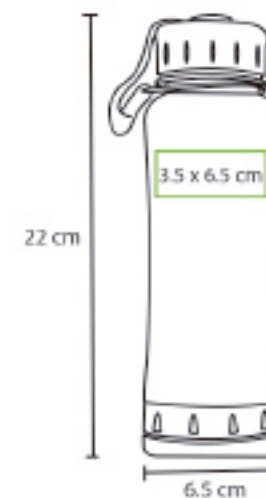

TE-17

Cilindro Malaga

Cilindro fabricado en policarbonato con tapa de polietireno, capacidad de 700 ml.
Impresión: Tampografía.

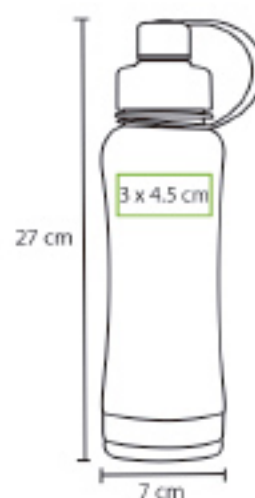

TE-18

Cilindro Sevilla

Cilindro fabricado en policarbonato con tapa de aluminio, capacidad de 600 ml.
Impresión: Tampografía.

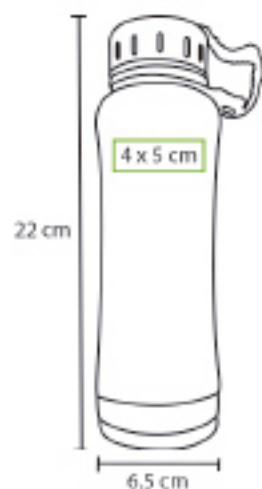

TE-29

Termo Banús

Termo de acero inoxidable con tapa de polipropileno aislada para conservar la temperatura.
Capacidad 300 ml. Incluye caja de cartón.
Impresión: Serigrafía o tampografía.

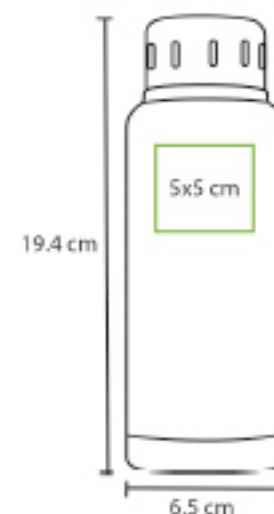

TE-19

Cilindro Valencia

Cilindro mini fabricado en policarbonato con tapa de aluminio, capacidad de 350 ml.
Impresión: Tampografía.

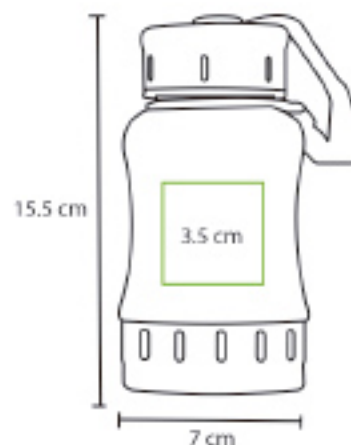

TH-11

Bocina Munich

Bocina de escritorio para reproductores de MP3 con cable USB.
Impresión: Serigrafía o tampografía.

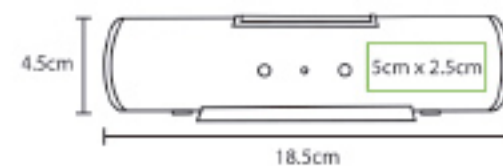

TX-10

Maleta Cádiz

Maleta multiusos fabricada en Nylon corrugado, con cierres, asa para colgar y brújula.
Impresión: Serigrafía o bordado.



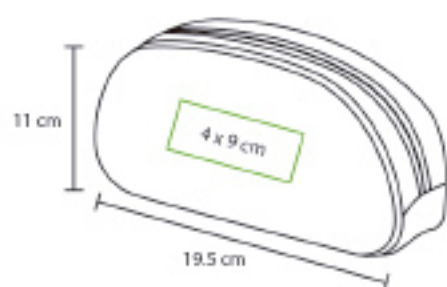

TX-19

Cosmetiquera

Bolsa lapicera de micro fibra.
Impresión: Serigrafía.



TX-34

Bolsa Maxi

Bolsa de playa fabricada en poliéster 600D.
Incluye neceser.
Impresión: Serigrafía.

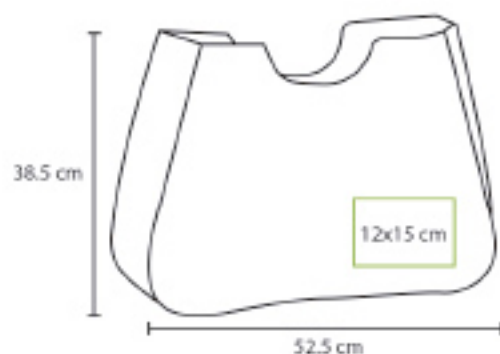



MOCHILAS Y MALETAS



TX-01

Maleta Córdoba

Maleta deportiva plegable.

Colores: Azul, rojo y blanco.

Impresión: Serigrafía o bordado.

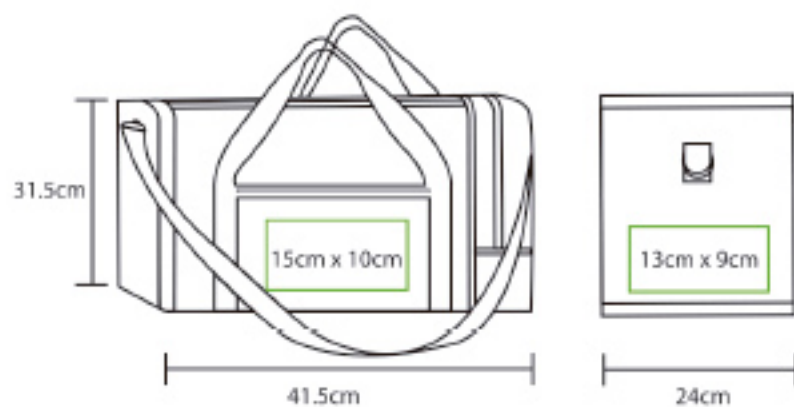



TX-02

Maleta Nápoles

Maleta deportiva multiusos.

Colores: Azul, rojo y negro.

Impresión: Serigrafía o bordado.

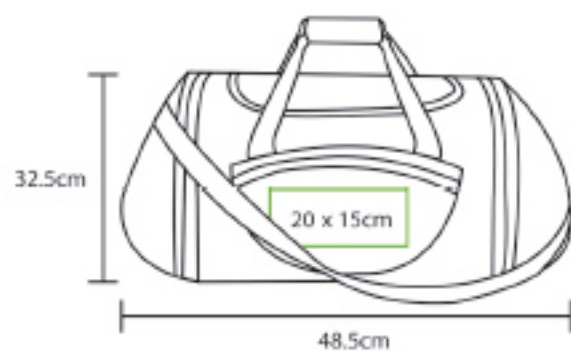

TX-10

Maleta Explorer

Maleta fabricada en nylon corrugado con llavero y brújula.

Colores: Azul, rojo, rosa y negro.
Impresión: Serigrafía o bordado.



TX-12

Maleta Budapest

Maleta multiusos fabricada en nylon,
con compartimento para calzado.
Colores: Azul, rojo, blanco y negro.
Impresión: Serigrafía o bordado.

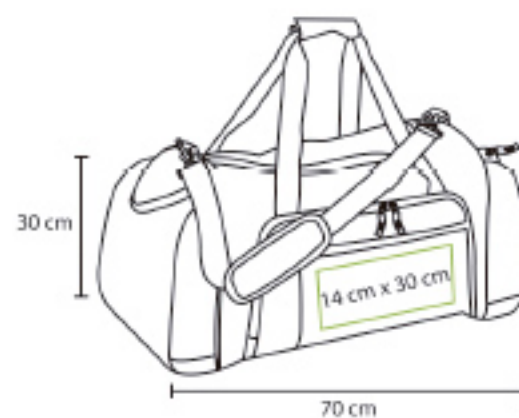

TX-17

Maleta Xtreme

Maleta deportiva fabricada en nylon.

Colores: Azul, rojo y negro.

Impresión: Serigrafía o bordado.



TX-18

Mochila Nicklaus

Mochila tipo back pack con porta laptop.

Color negro con verde.

Impresión: Serigrafía o bordado.



TX-13

Mochila Sport

Mochila con bolsas laterales y funda para celular.
Colores: Azul, rojo, naranja y negro.
Impresión: Serigrafía o bordado.





TX-14

Mochila Escolar

Mochila back pack.

Colores: Naranja, negro, azul y rojo.

Impresión: Serigrafía o bordado.



TX-23

Mochila Bari

Mochila back pack escolar fabricada en PVC.
Colores: Rojo, negro y azul.
Impresión: Serigrafía o bordado.



TX-24

Mochila Carrara

Mochila back pack fabricada en PVC.
Colores: Azul, verde y negro.
Impresión: Serigrafía o bordado.



TX-25

Mochila Foggia

Mochila back pack fabricada en PVC.

Colores: Azul y rojo.

Impresión: Serigrafía o bordado.



TX-26

Mochila Castello

Mochila back pack fabricada en PVC.

Colores: Negro, azul y rojo.

Impresión: Serigrafía o bordado.



TX-27

Mochila Arezzo

Mochila back pack fabricada en loneta con nylon.

Colores: Verde, naranja, negro, gris, azul y rojo.

Impresión: Serigrafía o bordado.



TX-35

Mochila Taipei

Mochila Trolley con ruedas fabricada en poliéster,
parte trasera y cintas acolchonadas.

Colores: Rojo, azul y naranja.

Impresión: Serigrafía o bordado.





OFICINA

DK-05

Reloj Pared/Escritorio

Reloj con alarma, termómetro y fechador.
Incluye caja de cartón individual.
Impresión: Serigrafía.

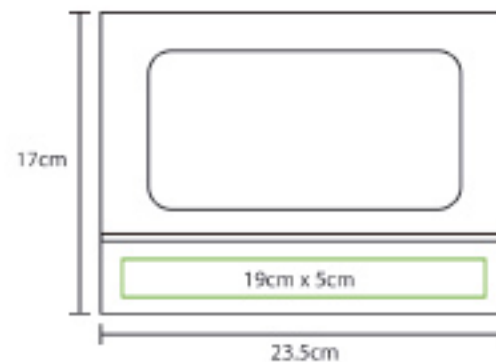

DK-13

Mouse Pad Gel

Mouse ergonómico con soporte de gel para muñeca.
Colores: Rojo, azul, blanco, amarillo y negro.
Impresión: Serigrafía.

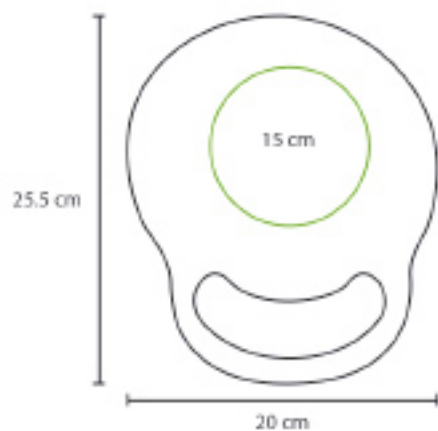

DK-20

Reloj Escritorio

Reloj de escritorio fabricado en aluminio.
Incluye caja individual.
Impresión: Serigrafía.

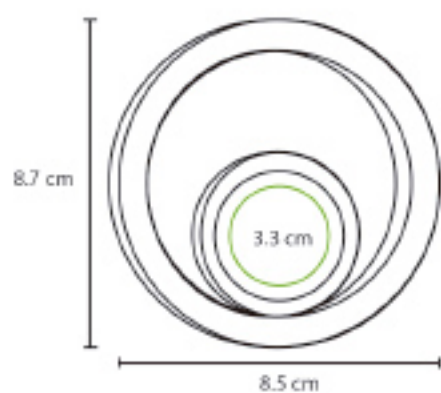

DK-21

Reloj Escritorio

Reloj de escritorio fabricado en aluminio.
Incluye caja individual.
Impresión: Serigrafía.

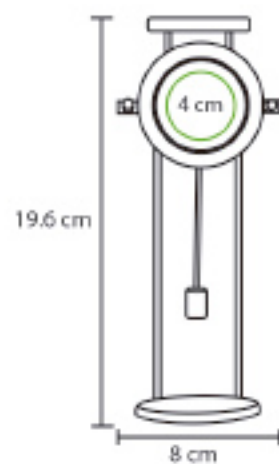

DK-22

Reloj Escritorio

Reloj de escritorio fabricado en aluminio con porta tarjetas y porta lápices.
Impresión: Tampografía, grabado láser o diamante.

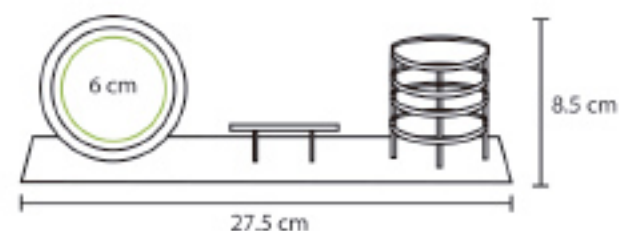

DK-23

Reloj Escritorio

Reloj de escritorio fabricado en aluminio con porta tarjetas.

Impresión: Tampografía, grabado láser o diamante.

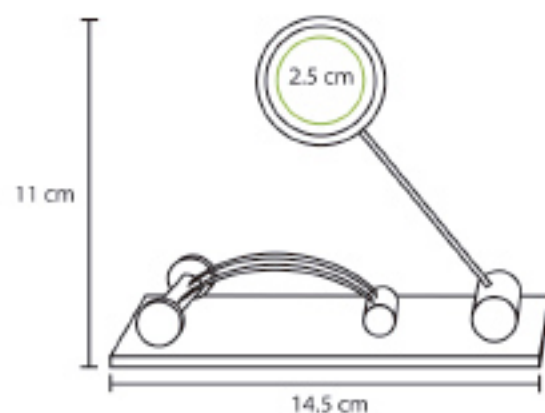

DK-26

Clip Porta Notas Niño

Porta notas metálico en forma de niño.
Impresión: Grabado láser o diamante.



DK-27

Clip Porta Notas Niña

Porta notas metálico en forma de niña.
Impresión: Grabado láser o diamante.



DK-31

Mouse Pad

Mouse pad con calculadora y notas adhesivas.
Impresión: Serigrafía o tampografía.

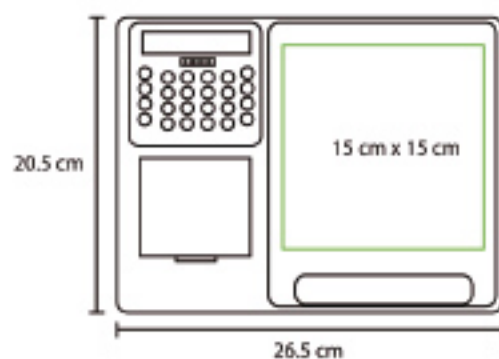

DK-28

Clip Porta Notas Casa

Porta notas metálico en forma de casa.
Impresión: Grabado láser o diamante.

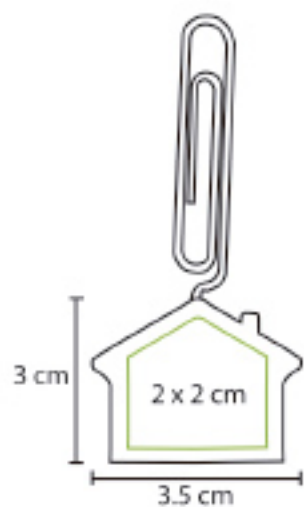

DK-29

Clip Porta Notas Estrella

Porta notas metálico en forma de estrella.
Impresión: Grabado láser o diamante.

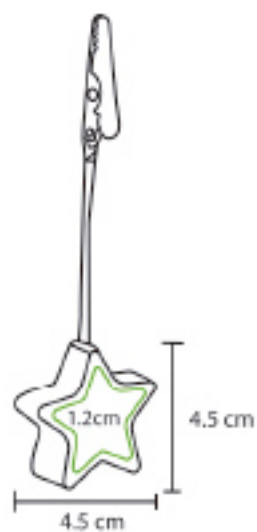

DK-30

Lupa

Lupa de plástico ergonómica de plástico.
Impresión: Serigrafía.

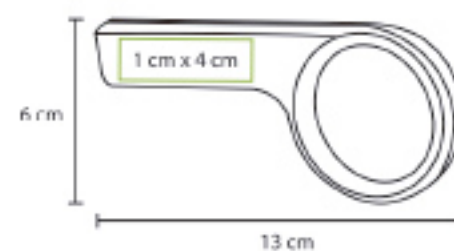

DK-32

Clip Porta Notas Cubo

Porta notas metálico en forma de cubo.
Impresión: Grabado láser o diamante.

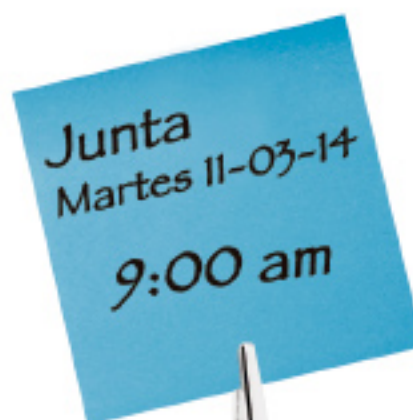
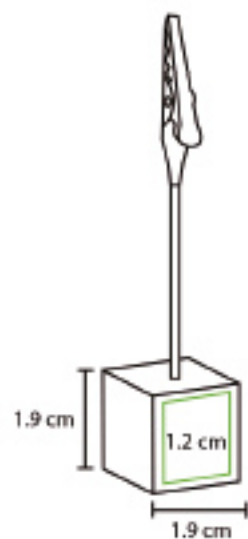

DK-34

Mouse Pad Madrid

Mouse pad con teclado y multi-puerto usb.
Impresión: Serigrafía.

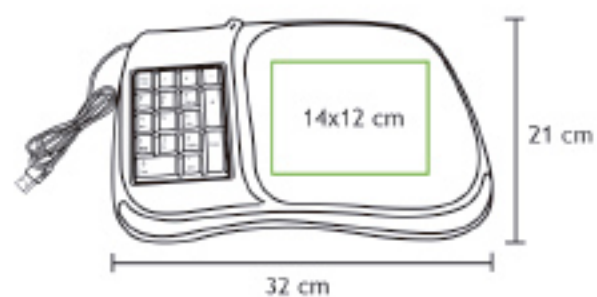

DK-35

Cubo Metálico

Cubo pisa papel para escritorio.
Con estuche individual
Impresión: Grabado láser o diamante.

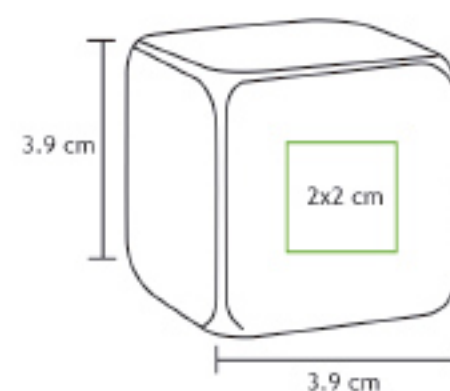

DK-36

Porta Retrato Zurich

Porta retrato de escritorio fabricado en curpiel color chocolate con porta celular.
Impresión: Grabado láser.

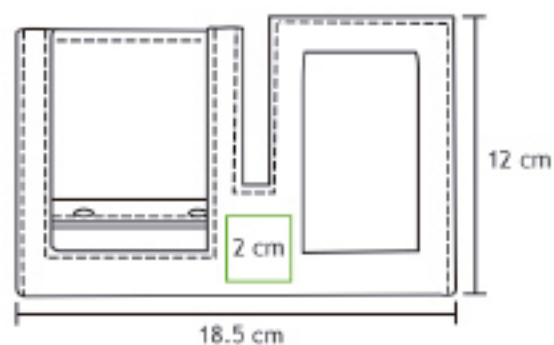

DK-37

Tabla Porta Documentos

Tabla de plástico con clip para documentos.

Colores: Humo, azul y rojo.

Impresión: Serigrafía.

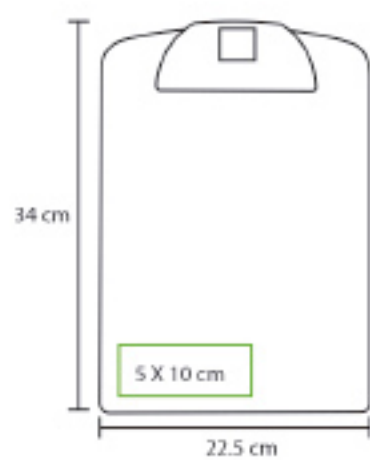

DK-38

Set de Notas Ecológico

Set ecológico de notas adhesivas y

banderitas de colores.

Impresión: Serigrafía o tampografía.

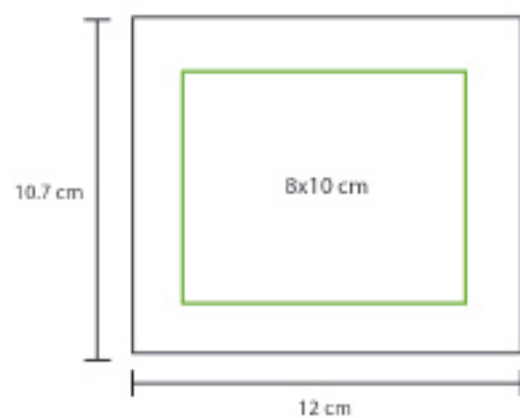

DK-42

Organizador de Escritorio

Organizador con 3 marca textos
y porta diurex color blanco.
Impresión: Serigrafía.

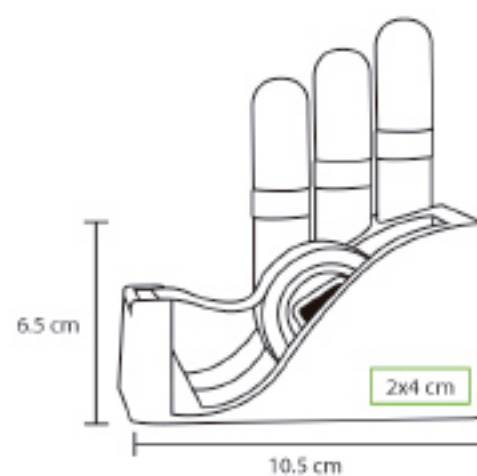

DK-43

Péndulo

Péndulo de Newton para escritorio.
Impresión: Serigrafía o grabado láser.

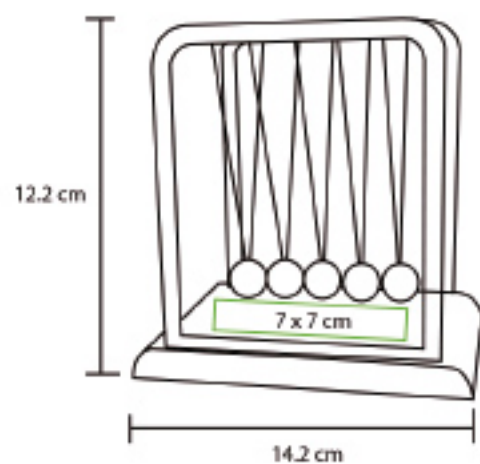

DK-52

Porta Gafete

Porta gafete retráctil de plástico.

Colores: Rojo, negro, rosa, azul y blanco.

Impresión: Serigrafía o goteado.

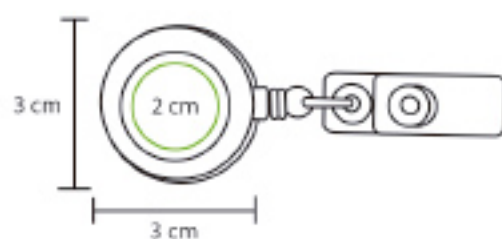

DK-59

Calculadora de Escritorio

Calculadora con set de notas adhesivas,

fabricado en material PVC.

Impresión: Serigrafía.

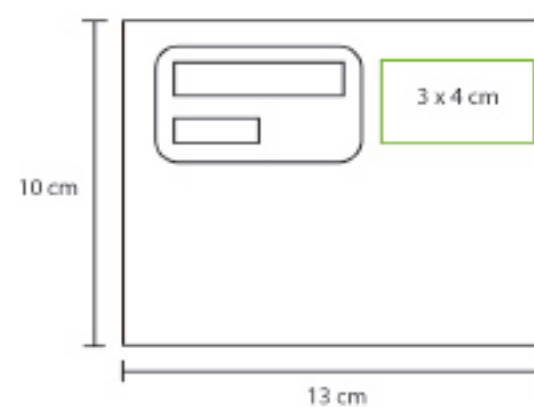



DK-58

Reloj de Arena

Reloj de arena para escritorio translúcido
fabricado en acrílico.
Impresión: Serigrafía.

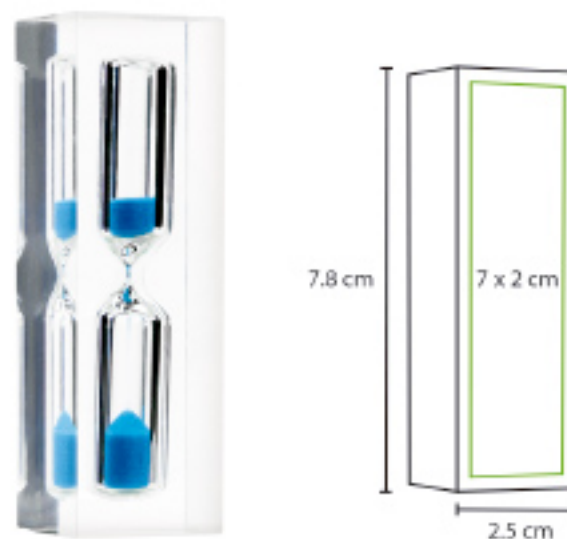

DK-60

Estuche con Notas Adhesivas

Estuche con notas adhesivas translúcido
fabricado en plástico.

Colores: Rojo, blanco, azul y humo.

Impresión: Serigrafía.

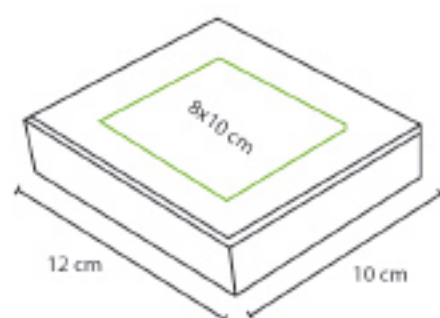

DK-56

Estrella Porta Mensajes

Porta mensajes en forma de estrella de plástico.

Colores: Rojo, azul y blanco.

Impresión: Tampografía.

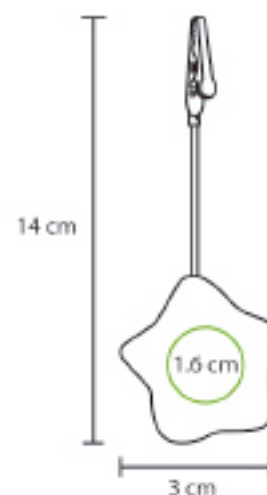

DK-62

Set de Escritorio

Set de escritorio con notas adhesivas y marca textos en 2 colores fabricado en plástico.

Impresión: Tampografía.

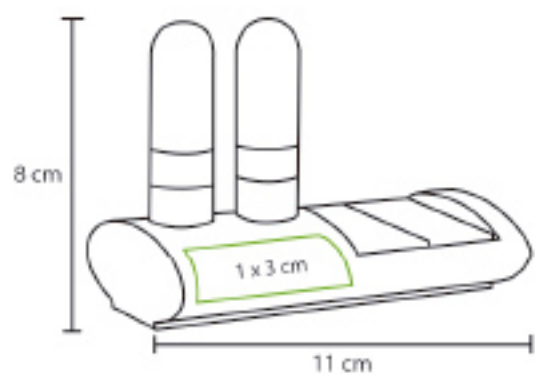

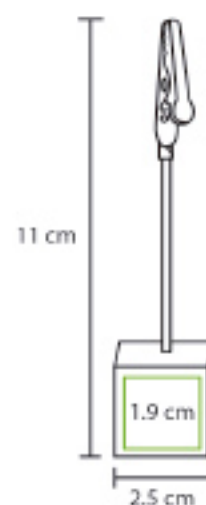

DK-57

Cubo Porta Mensajes

Porta mensajes en forma de cubo
fabricado en plástico.

Colores: Rojo, azul y blanco.

Impresión: Serigrafía o Tampografía.

MP-02

Clip con Imán

Clip porta papeles con imán fabricado en PVC.
Impresión: Serigrafía o tampografía.

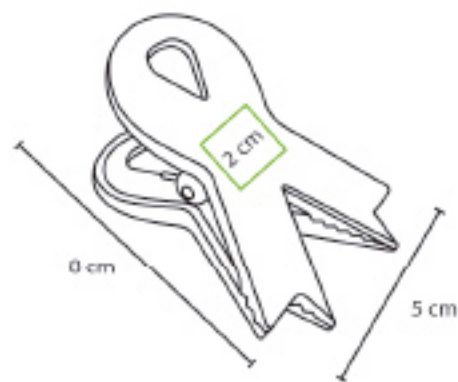

DK-61

Pisa Papeles

Clip con notas adhesivas de plástico.
Colores: Rojo, azul y blanco.
Impresión: Tampografía.

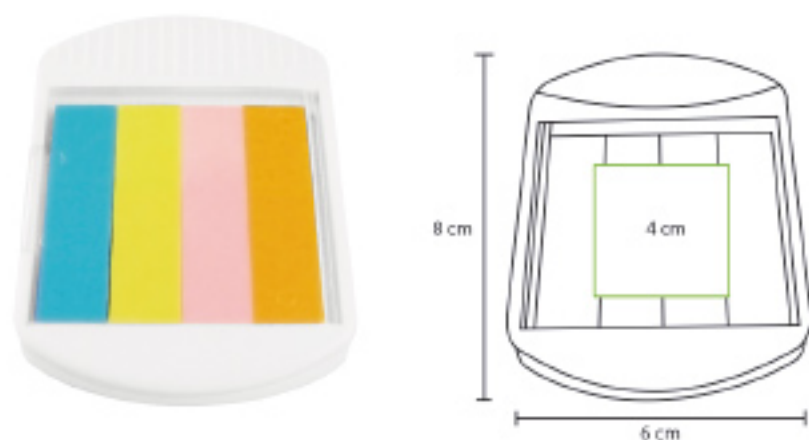

EX-15

Porta Gafete

Porta gafete metálico retráctil. Incluye caja de cartón individual.
Impresión: Grabado láser, diamante o goteado.

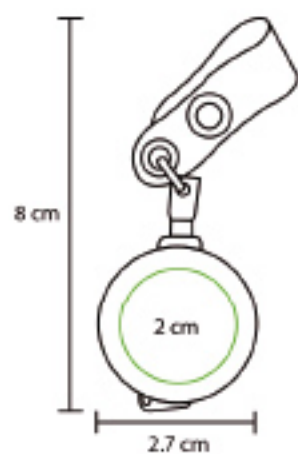

DK-63

Abre Cartas

Abre cartas para oficina de plástico.

Colores: Rojo, azul y blanco.

Impresión: Serigrafía o Tampografía.

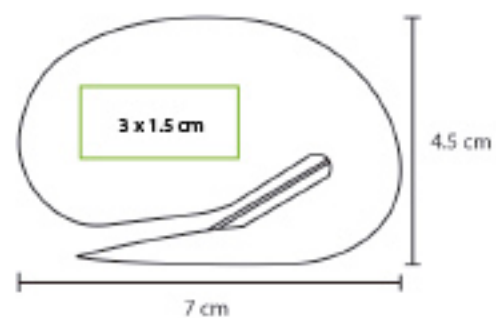

GL-02

Bolsa de Golf

Bolsa de golf con ruedas y 3 plumas en tinta azul, roja y negra.

Impresión: Grabado láser o diamante

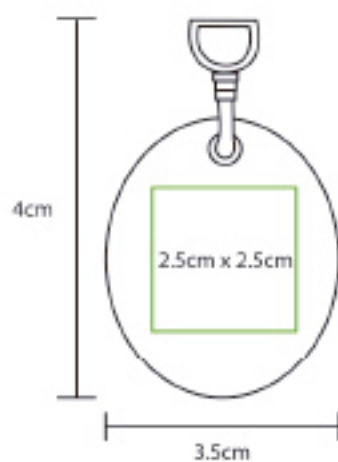

ST-01

Juego de Escritorio

Set de escritorio metálico con reloj, porta tarjetas, porta notas con pluma y abre cartas. Incluye caja de lujo. Impresión: Serigrafía o grabado láser.

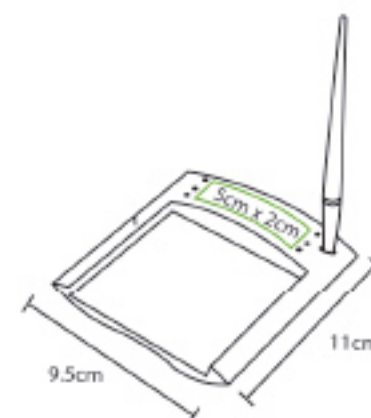
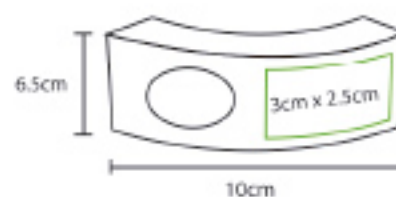
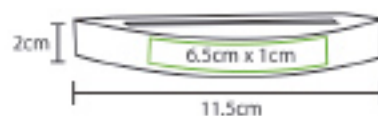
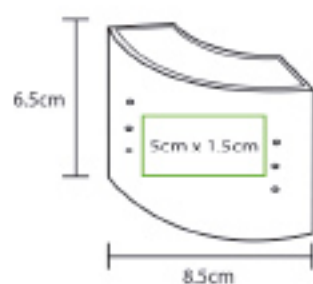
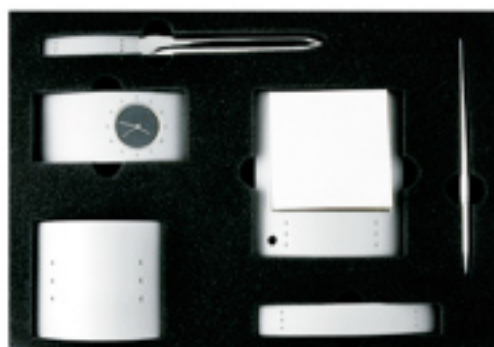

ST-12

Juego de Escritorio

Set de escritorio metálico con reloj,
 porta tarjetas, porta notas y porta celular.
 Incluye caja de lujo.
 Impresión: Serigrafía o grabado láser.

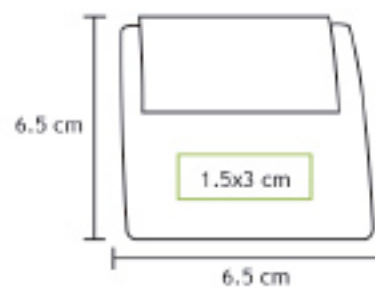
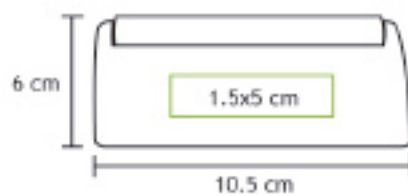
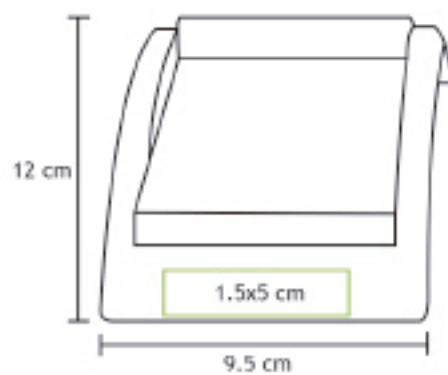



RELOJES

RK-04

Reloj Viena

Reloj ejecutivo marca BAKIÓ, fabricado en acero inoxidable. Resistente al agua (5 ATM). Incluye estuche de lujo Bakió. Impresión: Serigrafía.



RK-07

Reloj London

Reloj ejecutivo marca BAKIÓ, caja de acero inoxidable, correa de piel y cronómetro. Resistente al agua (5 ATM). Incluye estuche de lujo Bakió. Impresión: Serigrafía.



RK-05

Reloj Ibiza

Reloj ejecutivo marca BAKIÓ, caja de acero inoxidable, correa de nylón, cronómetro y fechador. Resistente al agua (5 ATM). Incluye estuche de lujo Bakió. Impresión: Serigrafía.

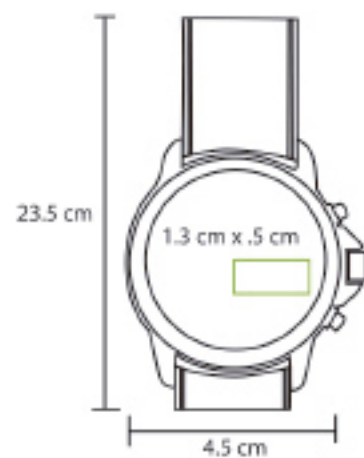

BAKIÓ
relojes



RK-09

Reloj Berlín

Reloj ejecutivo marca BAKIÓ, caja de acero inoxidable y correa de piel. Resistente al agua (5 ATM). Incluye estuche de lujo Bakió. Impresión: Serigrafía.



RK-11

Reloj Genova

Reloj ejecutivo marca BAKIÓ, caja de acero inoxidable, correa de piel italiana, fechador y cronómetro. Resistente al agua (5 ATM). Incluye estuche de lujo Bakió. Impresión: Serigrafía.



RK-13

Reloj Vera

Reloj ejecutivo marca BAKIÓ, caja de acero inoxidable y fechador. Resistente al agua (3 ATM). Incluye estuche de lujo Bakió. Impresión: Serigrafía.

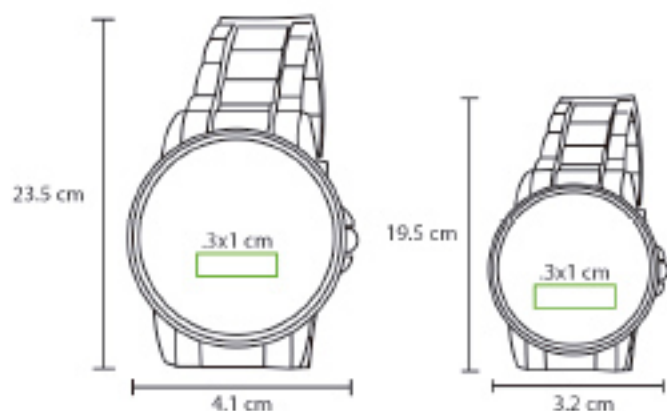

RK-12

Reloj Segovia

Reloj ejecutivo marca BAKIÓ, caja de acero inoxidable y fechador. Resistente al agua (3 ATM). Incluye estuche de lujo Bakió. Impresión: Serigrafía.

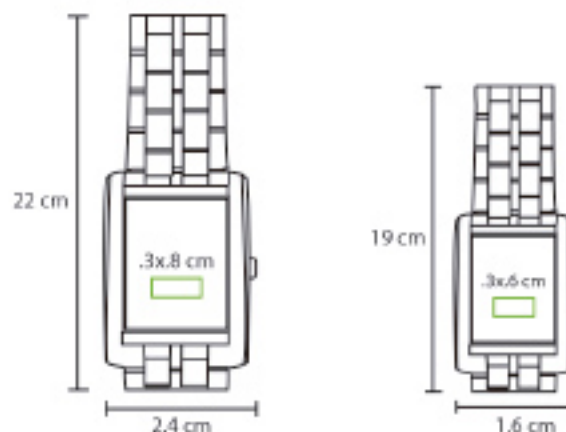

RELOJES INNOVATION

RP-01

Reloj de Pulso

Reloj con caja metálica giratoria y correa de piel.

Incluye estuche metálico.

Impresión: Serigrafía o Impresión digital.

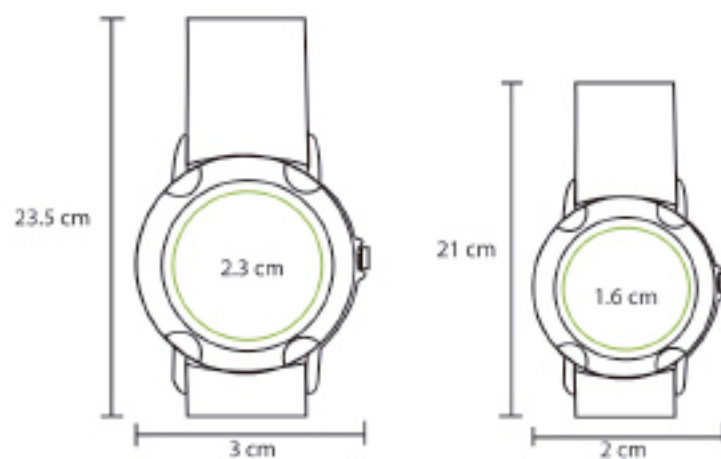

RP-02

Reloj de Pulso

Reloj con caja metálica y correa de piel.

Incluye estuche metálico.

Impresión: Serigrafía o Impresión digital.

RP-03

Reloj de Pulso

Reloj con caja metálica y correa de piel.
Incluye estuche metálico.
Impresión: Serigrafía o Impresión digital.



RP-04

Reloj de Pulso

Reloj con caja metálica bi-tono y correa de piel.
Incluye estuche metálico.
Impresión: Serigrafía o Impresión digital.

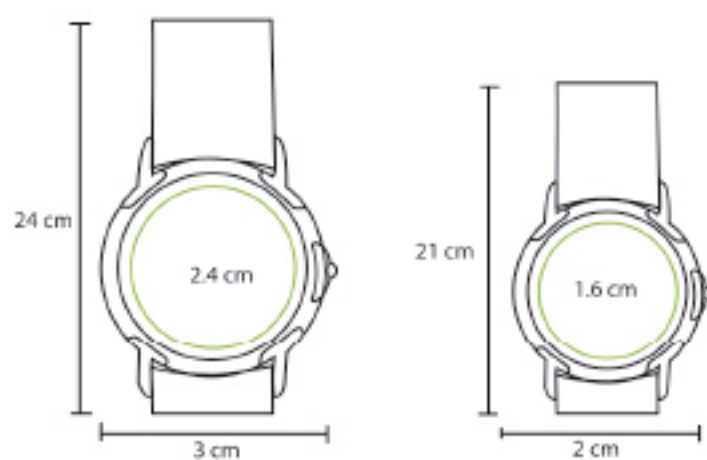

RP-05

Reloj de Pulso

Reloj con caja metálica y correa de plástico.
Incluye estuche metálico.
Impresión: Serigrafía o Impresión digital.

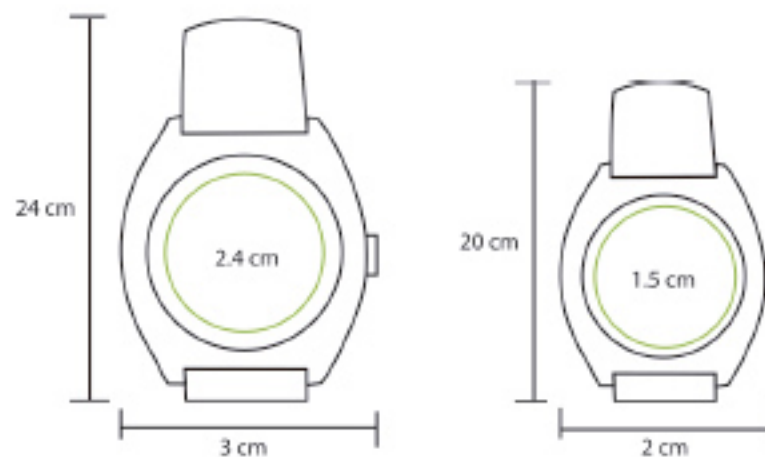

RP-06

Reloj de Pulso

Reloj con caja metálica y correa de piel.
Incluye estuche metálico.
Impresión: Serigrafía o Impresión digital.

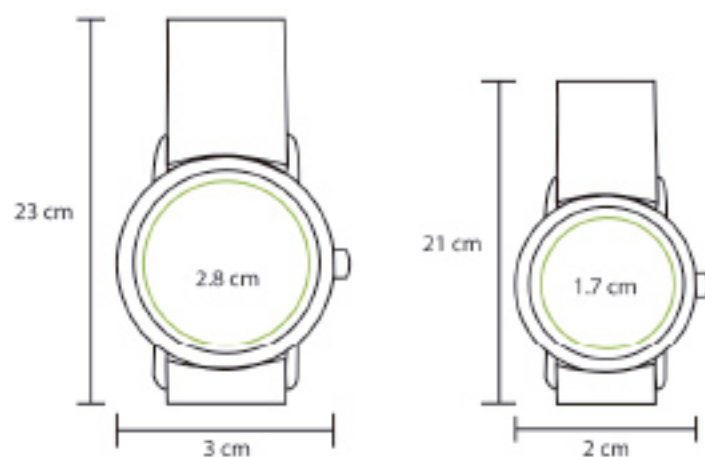

RP-07

Reloj de Pulso

Reloj con caja metálica y correa de piel.
Incluye estuche metálico.
Impresión: Serigrafía o Impresión digital.



RP-08

Reloj de Pulso

Reloj con caja metálica y correa de piel.
Incluye estuche metálico.
Impresión: Serigrafía o Impresión digital.



RP-09

Reloj de Pulso

Reloj con caja metálica, números romanos y correa de piel.
Incluye estuche metálico.
Impresión: Serigrafía o Impresión digital.

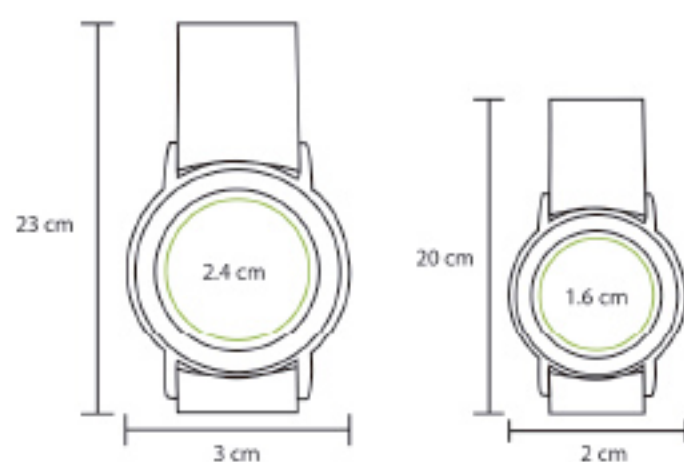

RELOJES INNOVATION



RP-10

Reloj de Pulso

Reloj con caja metálica y correa de piel.
Incluye estuche metálico.
Impresión: Serigrafía o Impresión digital.

RP-11

Reloj de Pulso

Reloj con caja metálica, números grabados en el bisel y correa de piel. Incluye estuche metálico.
Impresión: Serigrafía o Impresión digital.



RP-12

Reloj de Pulso

Reloj con caja metálica y correa de piel.
Incluye estuche metálico.
Impresión: Serigrafía o Impresión digital.



RP-13

Reloj de Pulso

Reloj con caja metálica y correa de piel.
Incluye estuche metálico.
Impresión: Serigrafía o Impresión digital.



RP-14

Reloj de Pulso

Reloj con caja metálica y correa de piel.
Incluye estuche metálico.
Impresión: Serigrafía o Impresión digital.

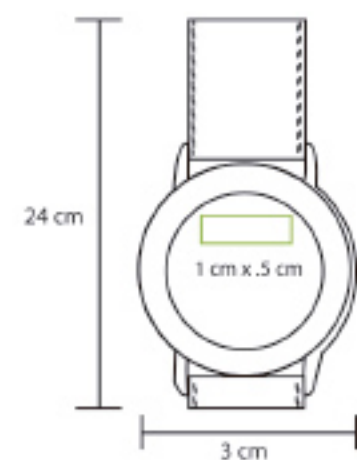

RP-15

Reloj de Pulso

Reloj con caja metálica y correa de piel.
Incluye estuche metálico.
Impresión: Serigrafía o Impresión digital.

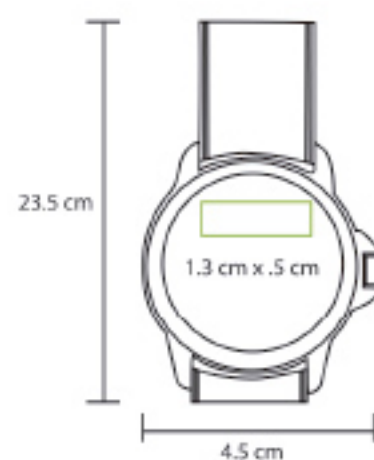



RP-16

Reloj de Pulso

Reloj con caja metálica y correa de piel.
Incluye estuche metálico.
Impresión: Serigrafía o Impresión digital.

RP-18

Reloj de Pulso

Reloj con caja metálica rectangular y correa de piel.
Incluye estuche metálico.
Impresión: Serigrafía o Impresión digital.



RP-19

Reloj de Pulso

Reloj metálico con fechador.
Incluye estuche metálico.
Impresión: Serigrafía o Impresión digital.



RP-21

Reloj de Pulso

Reloj metálico.

Incluye estuche metálico.

Impresión: Serigrafía o Impresión digital.



RP-22

Reloj de Pulso

Reloj metálico.

Incluye estuche metálico.

Impresión: Serigrafía o Impresión digital.



RP-23

Reloj de Pulso

Reloj metálico.

Incluye estuche metálico.

Impresión: Serigrafía o Impresión digital.

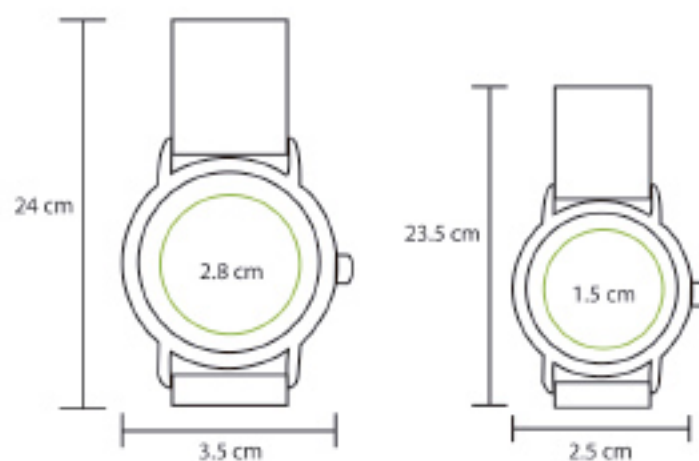

RP-24

Reloj de Pulso

Reloj metálico bi-tono con números romanos.

Incluye estuche metálico.

Impresión: Serigrafía o Impresión digital.

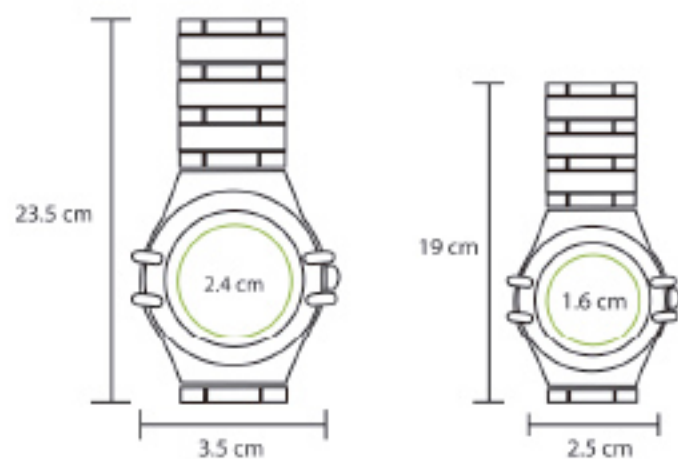

RP-25

Reloj de Pulso

Reloj metálico con números romanos.
Incluye estuche metálico.
Impresión: Serigrafía o Impresión digital.

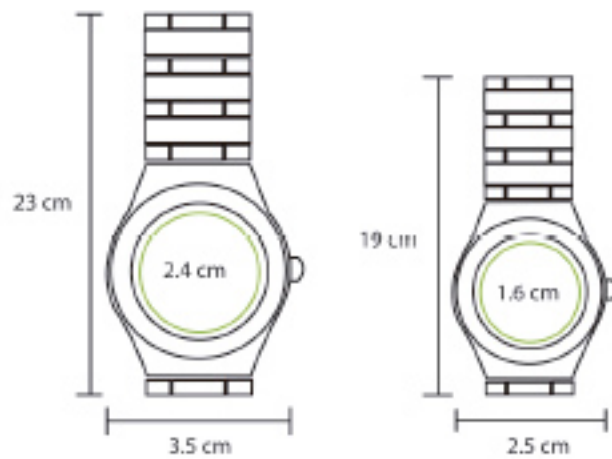

RP-28

Reloj de Pulso

Reloj con caja metálica giratoria y correa de nylon con velcro. Incluye estuche metálico.
Colores: Azul y negro.
Impresión: Serigrafía o Impresión digital.



RP-26

Reloj de Pulso

Reloj con caja metálica con dial giratorio y correa de plástico. Incluye estuche metálico.
 Colores: Azul marino, rojo, negro, azul y naranja.
 Impresión: Serigrafía o tampografía.

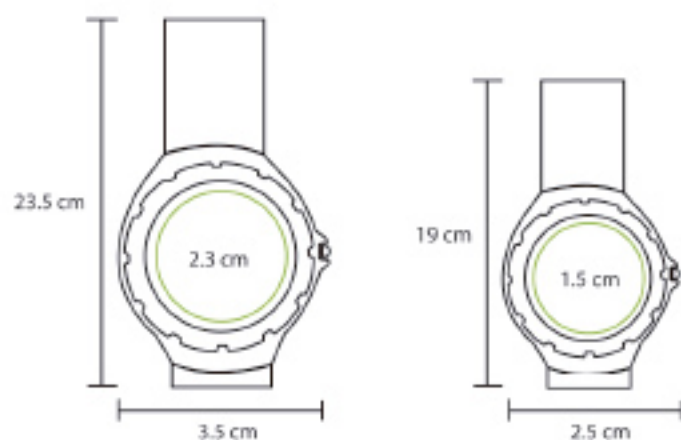

RP-27

Reloj de Pulso

Reloj con caja metálica giratoria y correa de plástico.

Incluye estuche metálico.

Colores: Amarillo, rojo, azul y negro.

Impresión: Serigrafía o Impresión digital.

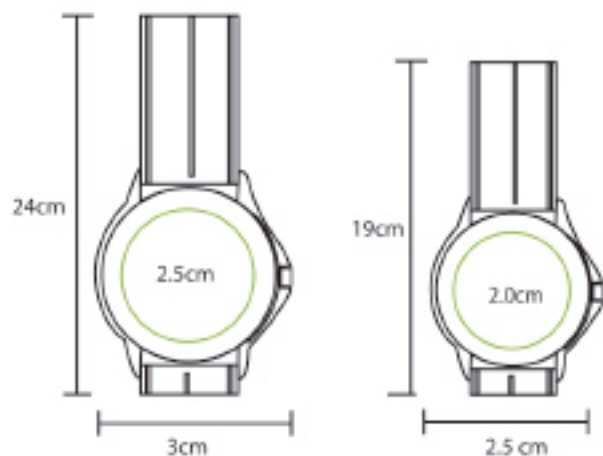

RELOJES INNOVATION



RP-29

Reloj de Pulso

Reloj con caja metálica y correa de nylon con velcro. Incluye estuche metálico.
Impresión: Serigrafía o Impresión digital.

RP-30

Reloj de Pulso

Reloj de plástico con estuche de plástico.
Colores: Verde, azul, negro y rojo.
Impresión: Serigrafía o Impresión digital.





RP-33

Reloj de Pulso

Reloj metálico con correa de plástico.
Incluye estuche metálico.
Impresión: Serigrafía o Impresión digital.

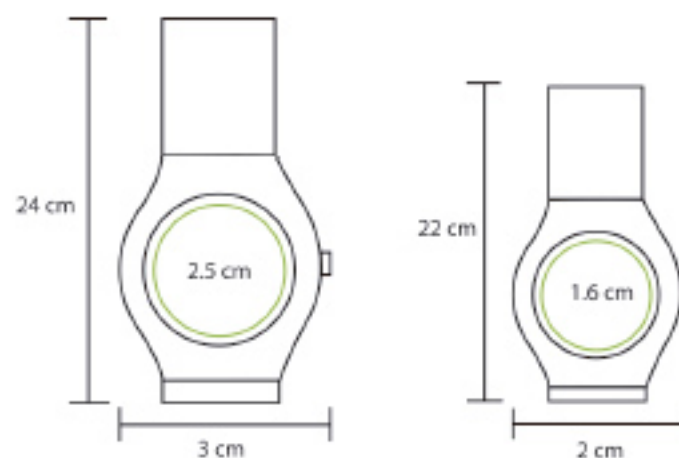

RP-36

Reloj de Pulso

Reloj con bisel giratorio y correa de plástico.
Incluye estuche metálico.
Impresión: Serigrafía o Impresión digital.

RP-38

Reloj de Pulso

Reloj metálico.
Incluye estuche metálico.
Impresión: Serigrafía o Impresión digital.



RP-37

Reloj de Pulso

Reloj sport con correa de plástico y bisel en colores.
Colores: Plata, verde, azul, naranja y negro.
Incluye estuche metálico.
Impresión: Serigrafía o Impresión digital.



RP-39

Reloj de Pulso Massive

Reloj con correa de piel.
Colores: Café y negro.
No incluye estuche.
Impresión: Serigrafía o Impresión digital.

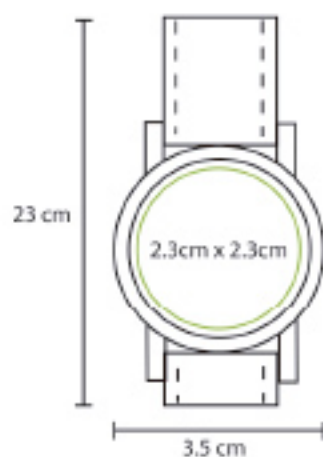

RP-40

Reloj de Pulso

Reloj rectangular con correa de piel.

Incluye estuche metálico.

Impresión: Serigrafía o Impresión digital.

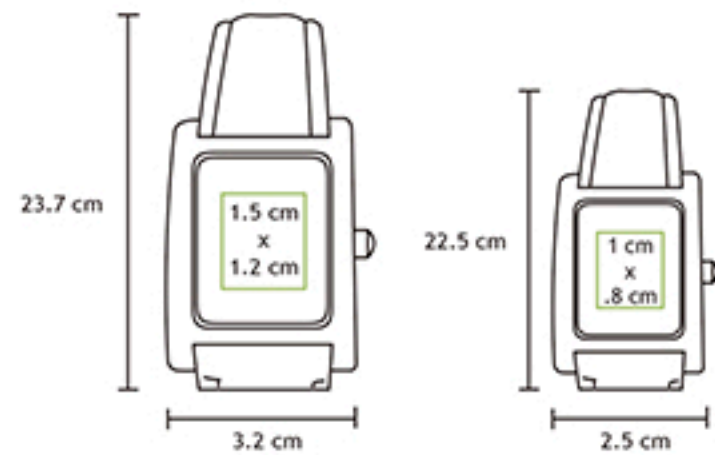

RP-41

Reloj de Pulso

Reloj con arillo giratorio y correa de piel.

Incluye estuche metálico.

Impresión: Serigrafía o Impresión digital.



■■ ANTONIO MIRO ■■ RP-45

Reloj de Pulso

Reloj con correa de piel y cristal mineral, resistente al agua con maquinaria Japonesa.

Incluye estuche Antonio Miro.

Impresión: Serigrafía o Impresión digital.



RELOJES INNOVATION

RP-42

Reloj de Pulso

Reloj con fechador y correa de silicón. Incluye estuche metálico.

Colores: Blanco y negro.

Impresión: Serigrafía o tampografía.



RP-43

Reloj de Pulso

Reloj de brazalete flexible. No incluye estuche.

Colores: Rojo, azul, rosa, morado, blanco y negro.

Impresión: Tampografía o Impresión digital.

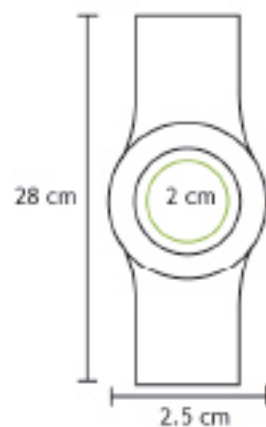

RP-44

Reloj de Pulso

Reloj fabricado en silicón.

Colores: Negro, azul, rojo, rosa, blanco y morado.
Impresión: Serigrafía o Impresión digital.



ST-02

Juego de Reloj, Pluma y Llavero

Reloj, llavero y bolígrafo metálico. Incluye caja de lujo.
Disponible en dama y caballero.
Impresión: Serigrafía, impresión digital o grabado láser.

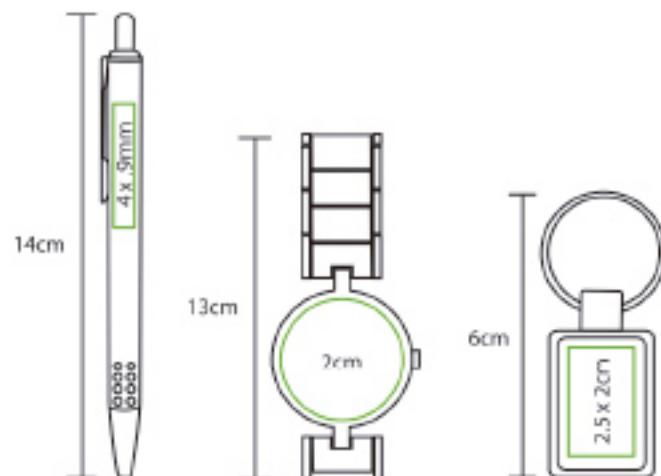

PD-01

Reloj de Pared Metálico

Reloj de pared con arillo metálico y protección de cristal.
Incluye caja de cartón individual y baterías.
Impresión: Serigrafía u Offset.

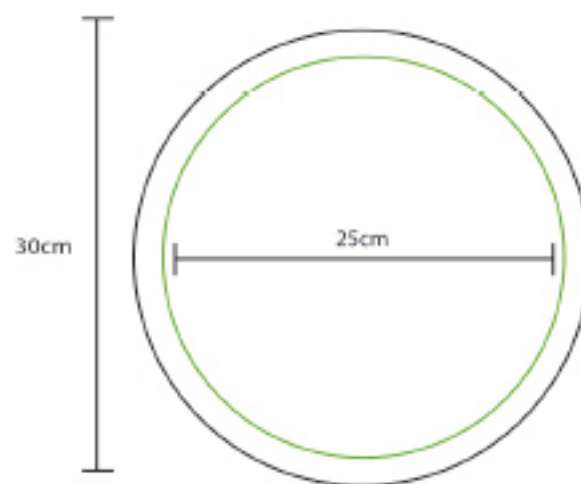

PD-03

Reloj de Pared

Reloj de pared con arillo de plástico y protección de cristal,
con hidrómetro y termómetro.
Incluye caja de cartón individual y baterías.
Impresión: Serigrafía.

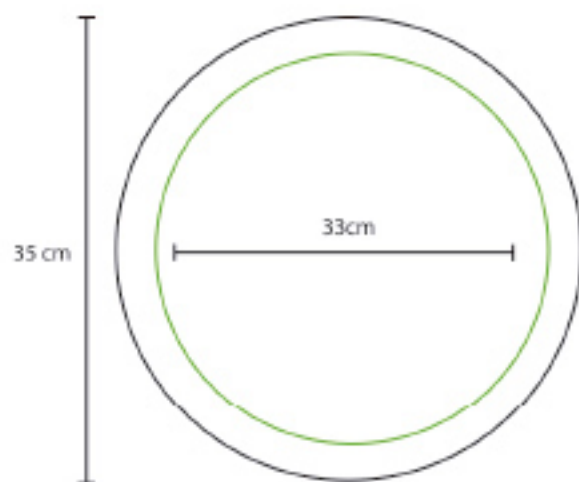

Reloj de Pared

Reloj de pared con arillo de plástico y protección de cristal.

Colores: Negro, azul, rojo, plata, verde y naranja.
Impresión: Serigrafía u Offset.

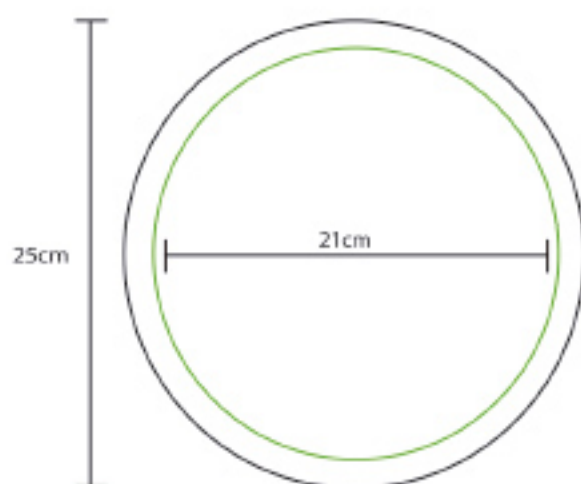



PD-04

Reloj de Pared Metálico

Reloj de pared con marco de acero inoxidable y protección de cristal. Incluye caja de cartón individual y baterías. Impresión: Serigrafía u Offset.

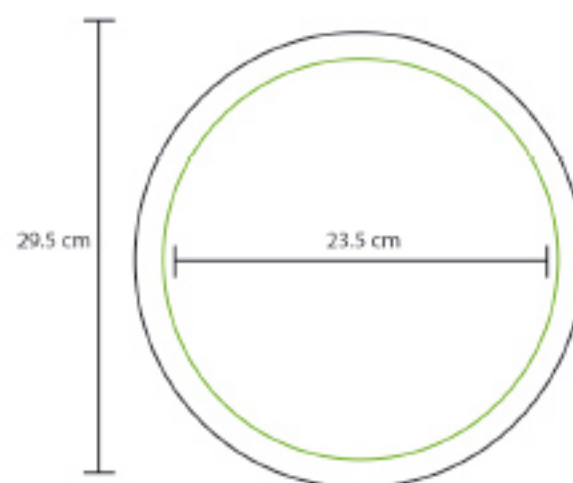

DK-15

Reloj de Escritorio Horizontal

Reloj metálico curvo. Incluye caja de cartón individual. Impresión: Serigrafía, grabado láser o diamante.



DK-16

Reloj de Escritorio Vertical

Reloj analógico metálico plata mate. Incluye caja de cartón individual. Impresión: Serigrafía, grabado láser o diamante.



DK-17

Reloj de Escritorio Bi-tono

Reloj metálico bi-tono plata con negro.
Incluye caja de cartón individual.
Impresión: Serigrafía, grabado láser o diamante.



DK-21

Reloj Escritorio

Reloj de escritorio fabricado en aluminio.
Incluye caja individual.
Impresión: Serigrafía.



DK-20

Reloj Escritorio

Reloj de escritorio fabricado en aluminio.
Incluye caja individual.
Impresión: Serigrafía.

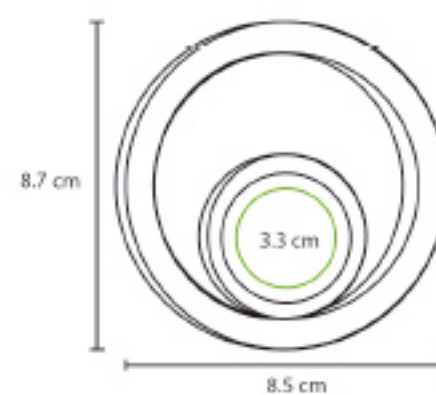

DK-17

Reloj de Escritorio Bi-tono

Reloj metálico bi-tono plata con negro.
Incluye caja de cartón individual.
Impresión: Serigrafía, grabado láser o diamante.



DK-21

Reloj Escritorio

Reloj de escritorio fabricado en aluminio.
Incluye caja individual.
Impresión: Serigrafía.



DK-20

Reloj Escritorio

Reloj de escritorio fabricado en aluminio.
Incluye caja individual.
Impresión: Serigrafía.

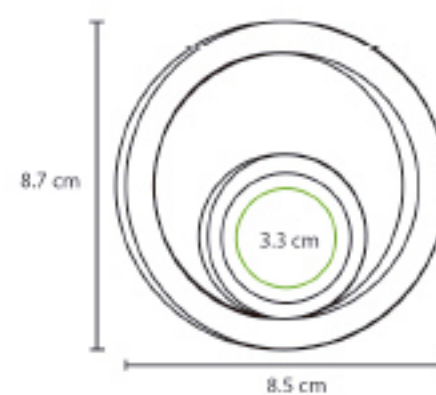

Opciones de carátulas

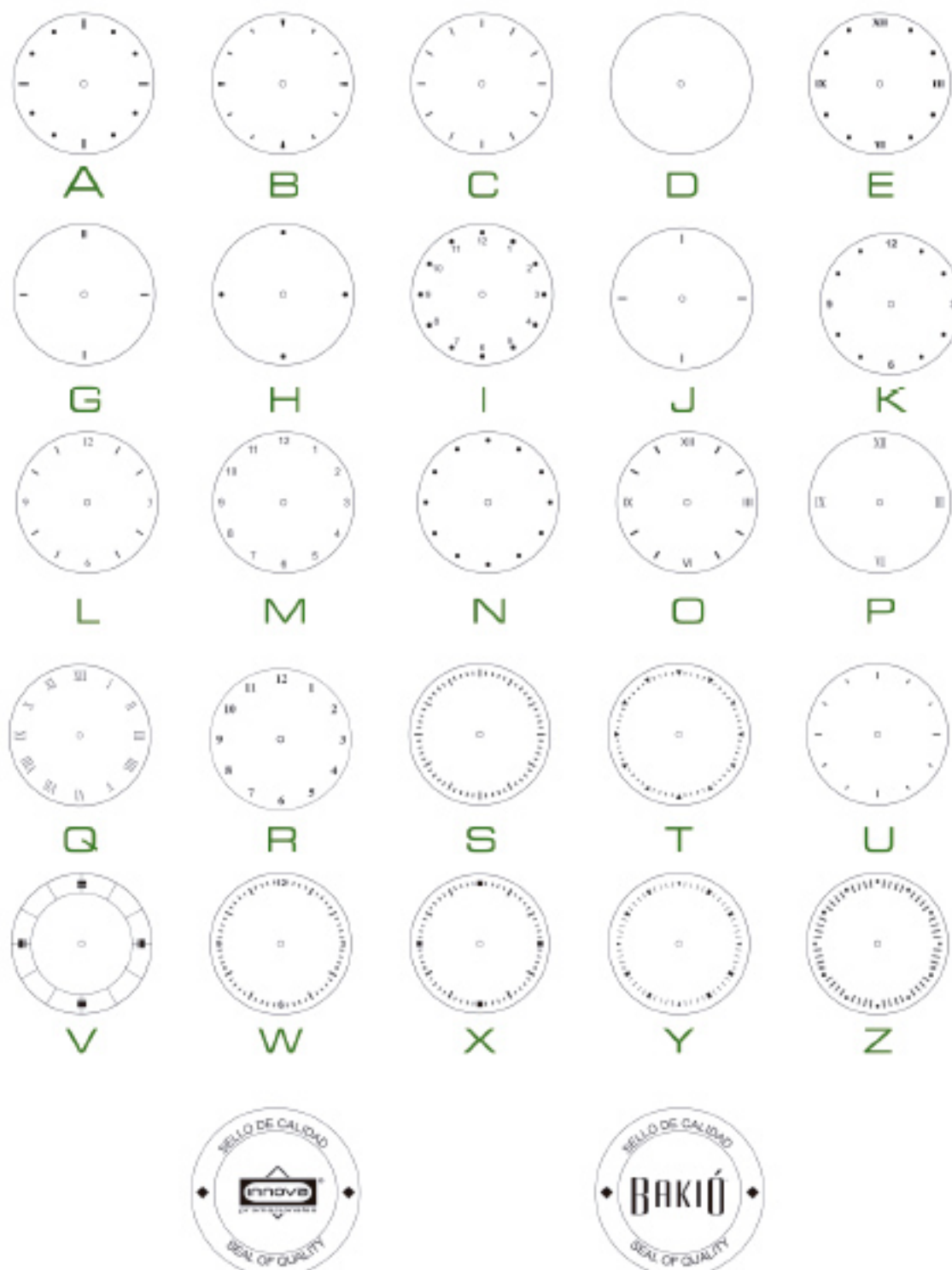

Los logotipos y marcas que se publican en este catálogo son con fines demostrativos e ilustrativos y no implican ningún tipo de licencia o distribución, la empresa no ha participado en sus diseños ni cuenta con ningún tipo de derechos de estas marcas, por lo que no están a la venta.

Innovation Line y Bakio son marcas registradas.

innovation
line

BAKIÓ
RELINOS



SPORT

GL-04

Executive Golf Set

Estuche para practicar golf.
Impresión: Serigrafía, tampografía,
grabado láser o diamante.

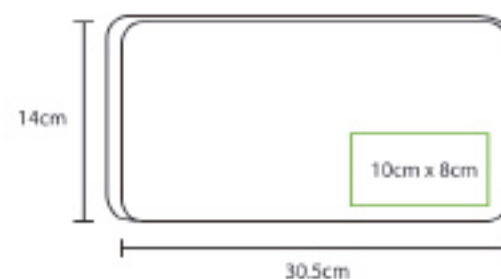

GL-07

Tees Golf Set

Bolsa con 25 tees de madera.
Impresión: Serigrafía o tampografía.

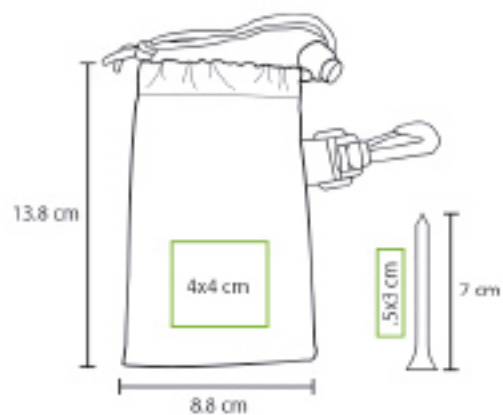

GL-08

Balls Golf Set

Estuche con 3 pelotas de golf amateur.
Impresión: Tampografía.

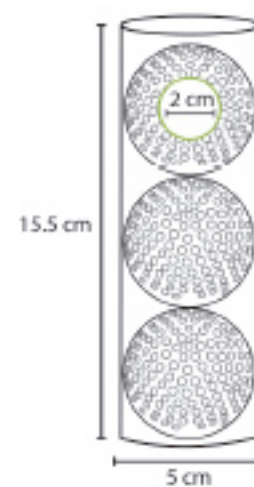

HE-06

Binoculares F1

Binoculares deportivos con cristal anti-reflejante y estuche.
Impresión: Tampografía.

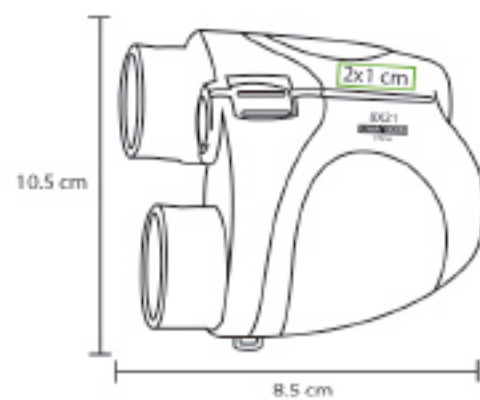

Aplaudidores

Globo aplaudidor de plástico para eventos, juego de 2 piezas.

Colores: Azul, blanco, rojo, naranja, verde y amarillo.
Impresión: Serigrafía.

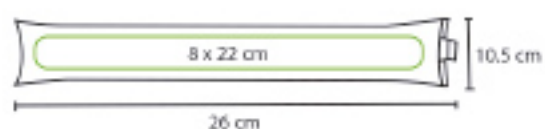

TE-13

Cilindro Deportivo City

Cilindro deportivo curvo con tapa de plástico.

Capacidad de 900 ml.

Colores: Azul, gris, rojo y naranja.

Impresión: Tampografía.





TAZAS Y CILINDROS



HM-04

Set de Tazas

Juego de 2 tazas fabricadas en acero inoxidable con mango de plástico y porta tazas.

Capacidad 190 ml.

Impresión: Serigrafía, grabado láser o diamante.

TE-01

Termo Metálico

Termo fabricado en acero inoxidable con cubierta aislante.

Capacidad de 600 ml.

Impresión: Serigrafía, grabado láser o diamante.

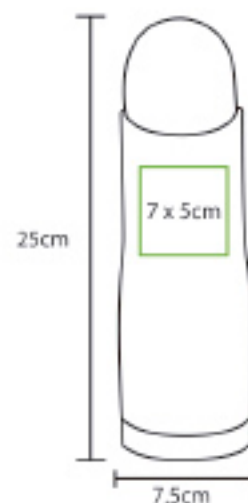

TE-02

Taza Siena

Taza térmica fabricada en acero inoxidable con mango, base de plástico y tapa anti-derrame. Capacidad de 400 ml.
Impresión: Serigrafía, grabado láser o diamante.

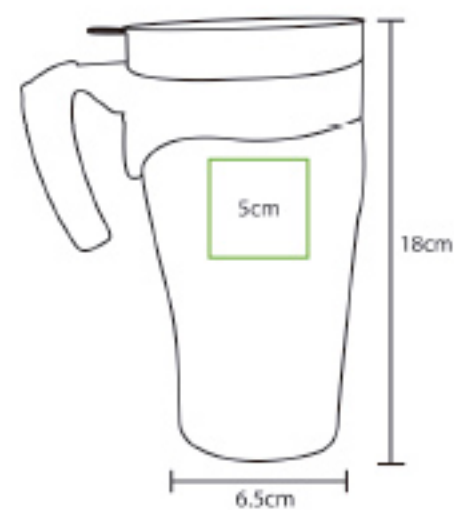

TE-06

Termo Jumbo

Termo metálico fabricado en acero inoxidable con tapa de chupón. Capacidad de 750 ml.
Impresión: Grabado láser o diamante.

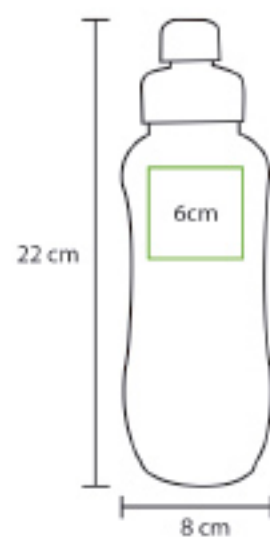

Taza Dolce

Taza térmica fabricada en acero inoxidable con cubierta plástica y tapa anti-derrame. Capacidad 500 ml.

Colores: Rojo, azul, blanco, negro.

Impresión: Serigrafía o tampografía.

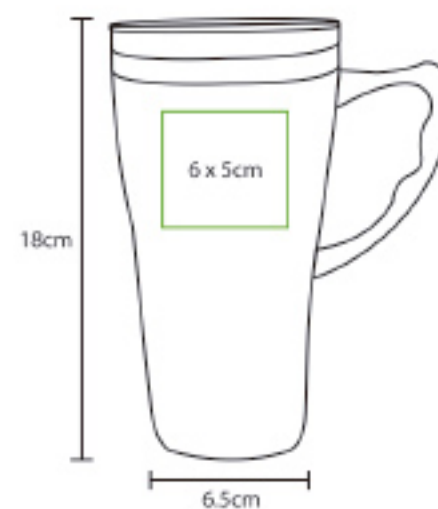



TE-07

Cilindro Sport

Cilindro metálico fabricado en acero inoxidable con tapa de chupón. Capacidad de 600 ml.

Colores: Azul y rojo.

Impresión: Serigrafía o grabado láser.

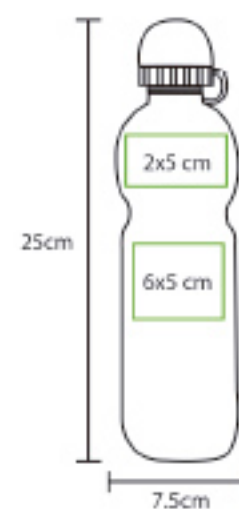

TE-08

Termo Spring

Termo metálico fabricado en acero inoxidable con tapa de chupón. Capacidad de 800 ml.
Impresión: Grabado láser o diamante.

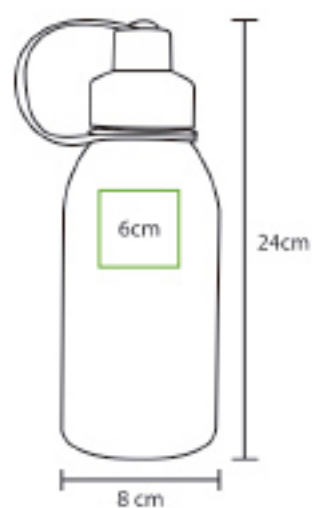



TE-10

Cilindro de Policarbonato

Cilindro con tapa de aluminio con capacidad de 650 ml.

Colores: Rojo, verde, rosa, humo, naranja y azul.

Impresión: Serigrafía o tampografía.

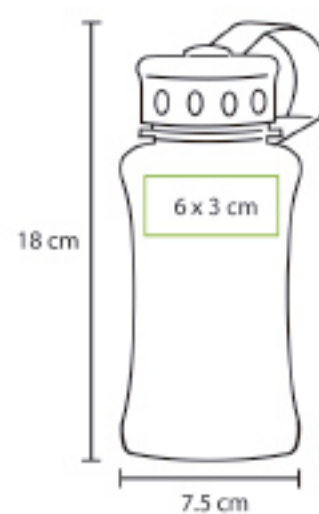

TE-11

Cilindro Altea

Cilindro de policarbonato con tapa de aluminio, capacidad de 650 ml.
Colores: Azul, rosa, verde, blanco, rojo y naranja.
Impresión: Tampografía.

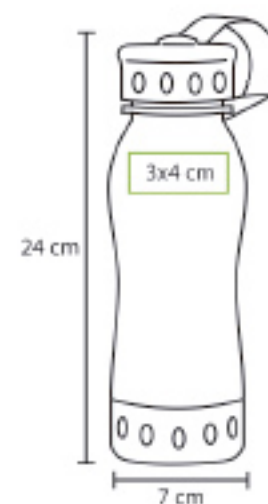

TAZAS Y CILINDROS



TE-12

Termo de Plástico

Termo de plástico con agarradera de hule. Capacidad de 450 ml.

Colores: Rojo, blanco y azul.

Impresión: Serigrafía o tampografía.

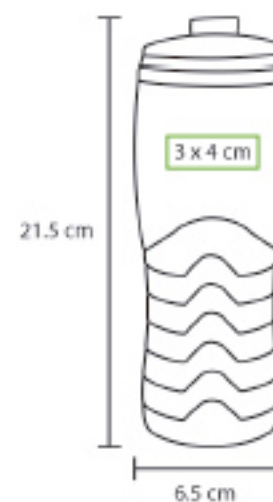

TE-13

Cilindro Deportivo City

Cilindro deportivo curvo con tapa de plástico.

Capacidad de 900 ml.

Colores: Azul, gris, rojo y naranja.

Impresión: Tampografía.

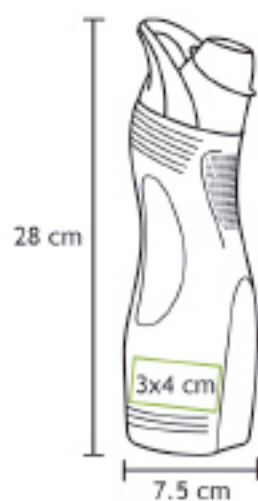



TE-14

Termo Metálico

Termo con arnés fabricado en acero inoxidable.

Capacidad de 800 ml.

Impresión: Serigrafía, tampografía o grabado láser.

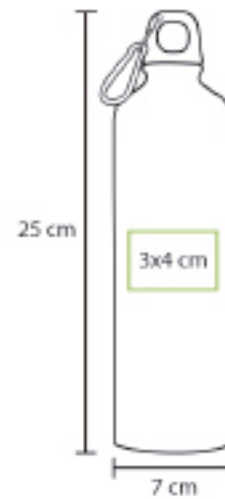

TE-15

Vaso Breeze

Vaso térmico fabricado en PVC con tapa y accesorios de color.

Colores: Azul, rojo y negro.

Impresión: Serigrafía o tampografía.



Doble capa

TE-16

Cilindro Toledo

Cilindro fabricado en policarbonato con tapa de aluminio, capacidad de 600 ml.

Colores: Rojo, rosa, humo, verde, naranja, morado, blanco y azul.

Impresión: Serigrafía o tampografía.

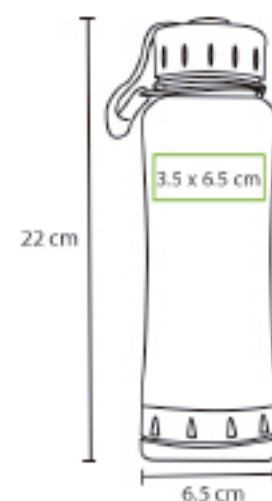

TE-17

Cilindro Malaga

Cilindro fabricado en policarbonato con tapa de polietireno, capacidad de 700 ml.

Colores: Azul, naranja, rosa y rojo.

Impresión: Tampografía.

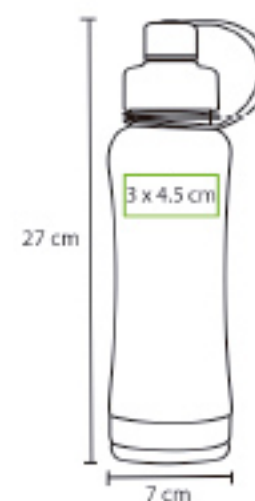

TE-18

Cilindro Sevilla

Cilindro fabricado en policarbonato con tapa de aluminio, capacidad de 600 ml.

Colores: Azul, naranja, rosa y rojo.

Impresión: Tampografía.

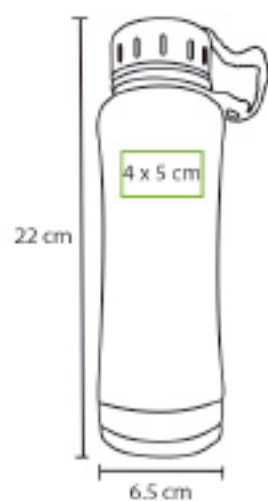

TE-19

Cilindro Valencia

Cilindro mini fabricado en policarbonato con tapa de aluminio, capacidad de 350 ml.
Colores: Azul, blanco, rojo, humo, rosa, naranja y morado.
Impresión: Tampografía.

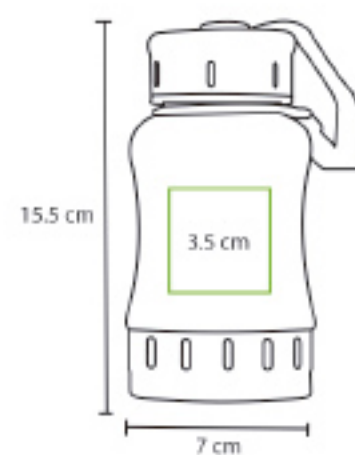

TE-20

Cilindro Mallorca

Cilindro fabricado en policarbonato con tapa de plástico, capacidad de 800 ml.
Colores: Azul, naranja, negro, blanco, verde y rojo.
Impresión: Tampografía.

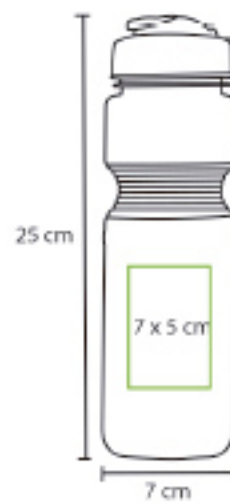

TE-21

Taza Cadiz

Taza térmica con interior en acero inoxidable, capacidad de 350 ml.
Colores: Azul, naranja, rojo, negro, verde, amarillo y morado.
Impresión: Serigrafía o tampografía.



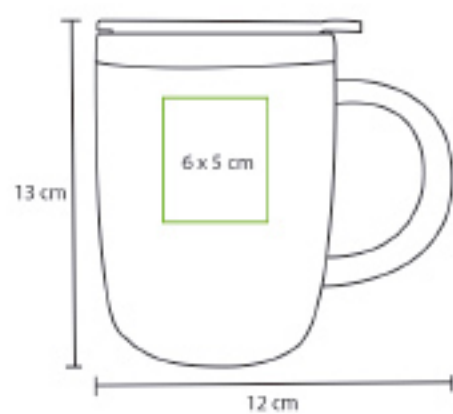

TE-22

Taza Bilbo

Taza térmica con interior en acero inoxidable,
capacidad de 400 ml.

Colores: Azul, naranja, blanco, morado y rojo.

Impresión: Serigrafía o tampografía.



TAZAS Y CILINDROS

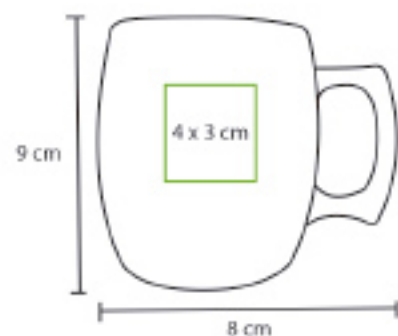

TE-23

Taza Oviedo

Taza fabricada en plástico AS, capacidad de 200 ml.

Colores: Azul, morado, rojo y verde.

Impresión: Tampografía.

TE-24

Taza Jáger

Taza térmica fabricada en poliestireno y prolipropileno.

Capacidad de 400 ml.

Colores: Verde, rojo, humo y azul.

Impresión: Tampografía.



TE-25

Cilindro Bakú

Cilindro de tritan con tapa de polipropileno y correa.

Capacidad de 700 ml.

Colores: Azul, morado, verde y rojo.

Impresión: Serigrafía o tampografía.

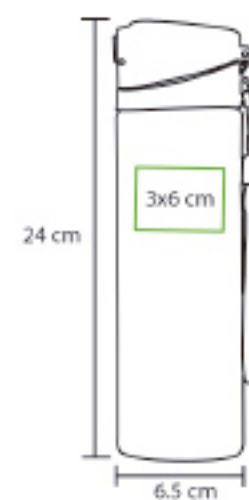

TE-26

Cilindro Poket

Cilindro de tritan con tapa de polipropileno.

Capacidad de 750 ml.

Colores: Azul, morado, rojo, negro, naranja y verde.

Impresión: Serigrafía o tampografía.



TE-27

Cilindro Praga

Cilindro de acero inoxidable con tapa de polipropileno y correa. Capacidad de 750 ml.

Colores: Azul, negro, blanco y rojo.

Impresión: Serigrafía o tampografía.



TE-28

Vaso Asís

Vaso fabricado en SAN doble pared con tapa de polipropileno. Capacidad de 530 ml. Colores: Azul, morado, rojo, negro, naranja y verde. Impresión: Tampografía.



TE-29

Termo Banús

Termo de acero inoxidable con tapa de polipropileno aislada para conservar la temperatura.
Capacidad 300 ml. Incluye caja de cartón.
Impresión: Serigrafía, tampografía o grabado láser.

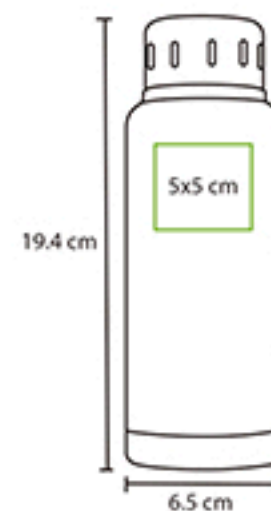

TE-30 ■■ ANTONIO MIRO ■■

Termo

Termo de acero inoxidable.
Capacidad 500 ml. Incluye estuche.
Impresión: Serigrafía, tampografía o grabado láser.

NUEVO

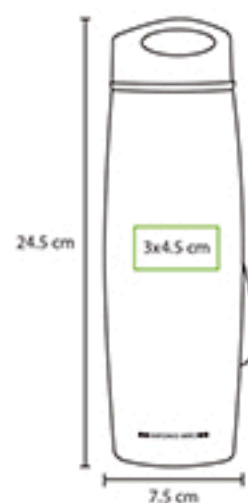



TECNOLOGÍA

TH-01

USB con Brújula

Memoria USB de plástico de 2 GB y 4 GB con brújula.
Incluye estuche metálico y cordón.
Colores: Azul, plata, amarillo, rojo y naranja.
Impresión: Serigrafía o tampografía.

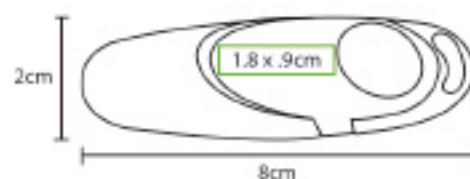

TH-02

USB Abatible

Memoria USB metálica con plástico de 2 GB y 4 GB.
Incluye estuche metálico y cordón.
Impresión: Serigrafía, grabado láser o diamante.

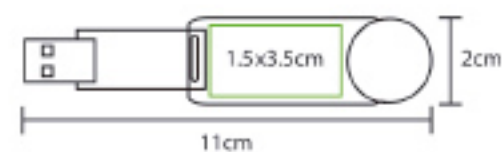

TH-07

Multiconector USB

Conector de puertos de plástico con luz,
3 dispositivos de USB, calendario, reloj y alarma.
Impresión: Serigrafía o tampografía.

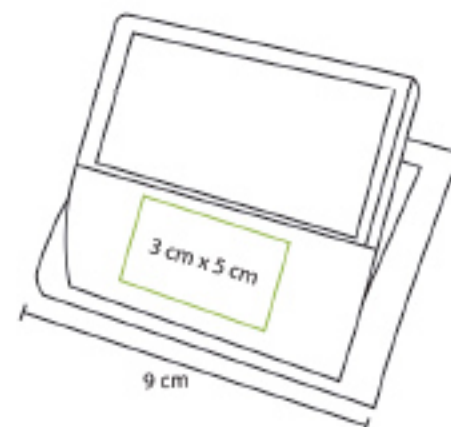

TH-09

USB Cairo

Llavero de curpiel con memoria USB de 2 GB y 4 GB.
Colores: Rojo y negro.
Impresión: Serigrafía, tampografía o grabado láser.

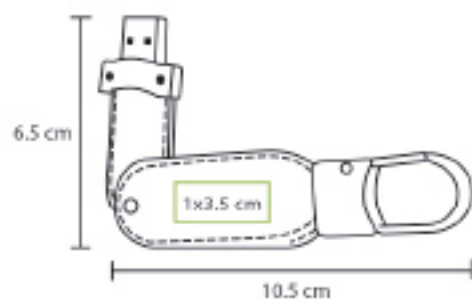

TH-11

Bocina Munich

Bocina de escritorio para reproductores de MP3 con cable USB.

Colores: Rosa, azul y plata.

Impresión: Serigrafía o tampografía.

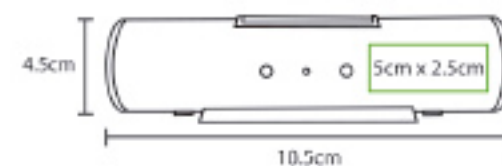

TH-13

Pluma USB

Pluma USB de 4 GB con señalador láser.

Incluye estuche metálico.

Colores: Negro y plata.

Impresión: Serigrafía o grabado láser.



TH-15

Kit de Computo

Kit con conector de USB para 4 puertos, mouse óptico y extensión USB. Incluye estuche. Impresión: Serigrafía.

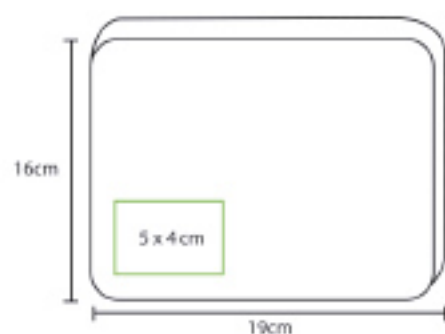

TH-19

USB 360°

Memoria USB de 4 GB y 8 GB, fabricada en plástico con metal. Colores: Rojo, azul, naranja y negro. Impresión: Serigrafía, tampografía o grabado láser.

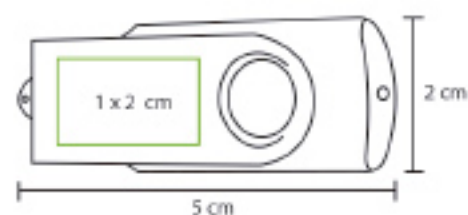

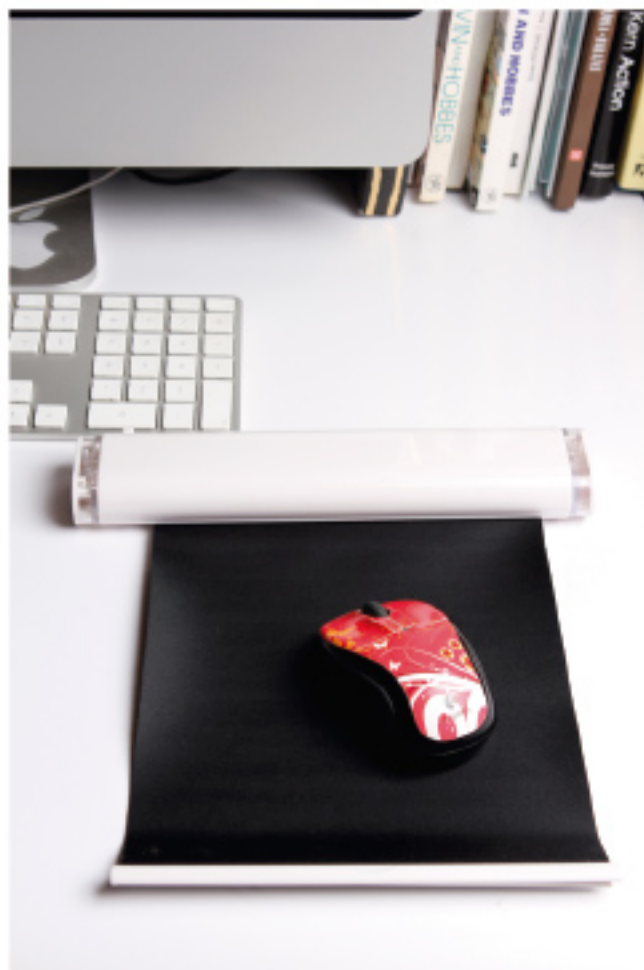

TH-17

Mouse Pad Retráctil

Tapete para mouse retráctil color blanco con multiconector USB.
Impresión: Serigrafía o tampografía.



TH-20

USB Llave

Memoria USB metálica en forma de llave de 4 GB.
Impresión: Serigrafía, tampografía o grabado láser.

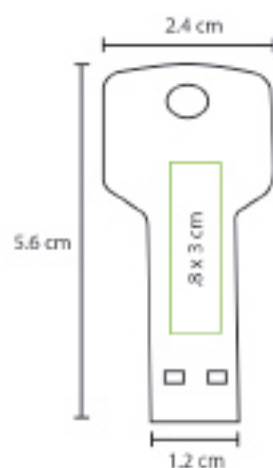

TH-21

Audifonos

Audifonos In-ear con estuche fabricado en ABS.

Colores: Negro, blanco, azul y rojo

Impresión: Serigrafía o tampografía.

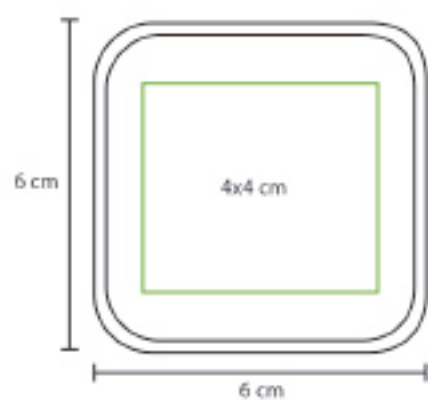

NUEVO



TH-22

Cargador

Cargador de iPhone/iPad para auto, fabricado en ABS.

Incluye caja individual

Colores: Rojo, azul, verde y blanco.

Impresión: Serigrafía o tampografía.

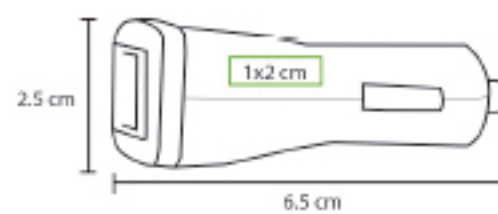

NUEVO



Bocina

Bocina con reloj y bluetooth. Pantalla LCD de 65 x 40 mm, alarmas, calendario y radio FM. Batería recargable USB. Impresión: Serigrafía o tampografía.

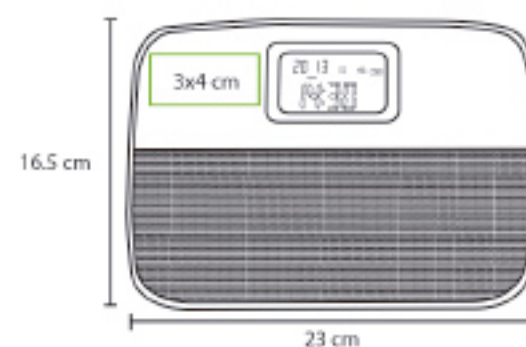

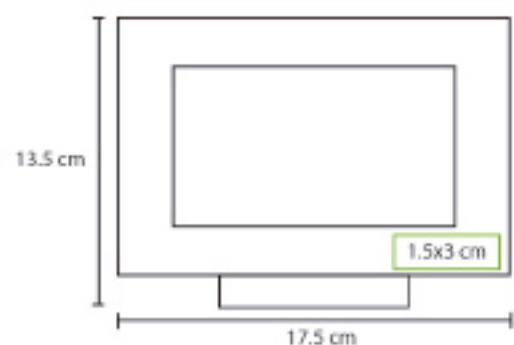

TH-25

Reloj Despertador

Reloj despertador con barómetro y termómetro.
Pantalla LED y marco ABS.
Impresión: Serigrafía o tampografía.

NUEVO



TH-23

Puntero Tyrso

Puntero para pantallas touch screen
y señalador láser. Incluye pilas.
Impresión: Serigrafía o tampografía.

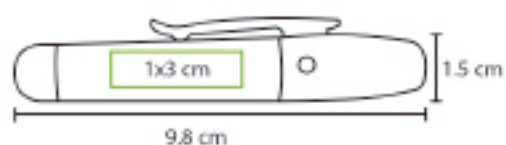

LASER



NUEVO



TH-26

Auricular Plex

Auricular y micrófono, mejora la calidad de las llamadas permitiendo el acceso a las demás funciones de su móvil mientras habla, conexión jack 3,5 mm.

Colores: Negro, azul, rojo, rosa y blanco.
Impresión: Serigrafía o tampografía.

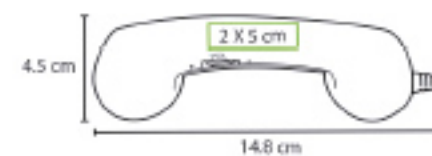

TH-27

Altavoz

Altavoz de conexión jack 3.5 mm 3 pilas AAA no incluidas.

Colores: Negro y blanco.

Impresión: Tampografía.

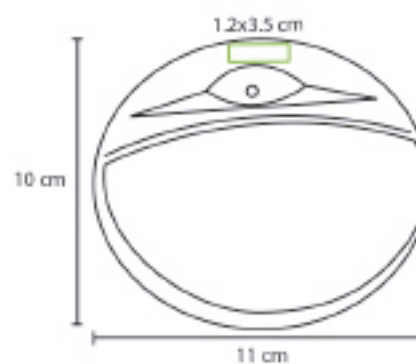

DK-34

Mouse Pad Madrid

Mouse pad con teclado y multi-puerto usb.

Impresión: Serigrafía.

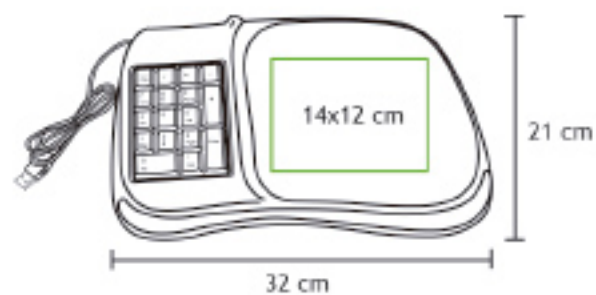



NUEVO

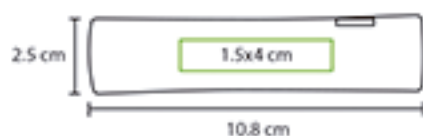

TH-28
Power Bank 2600
 Power Bank cilíndrico de 2,600 mAh, con lámpara, incluye cable USB con 5 conectores. Colores: Negro, rojo y blanco. Impresión: Serigrafía o tampografía.



TH-29

Power Bank 2400

Power Bank cuadrado de 2,400 mAh, incluye cable USB con 5 conectores. Colores: Negro, azul, morado, naranja y verde. Impresión: Serigrafía o tampografía.

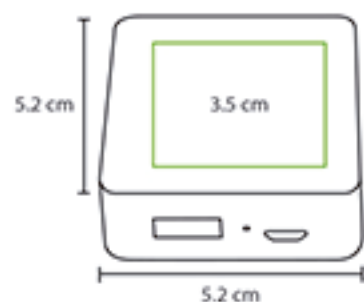

TH-30

Power Bank 6000

Power Bank rectangular de 6,000 mAh, con doble salida, incluye cable USB con 5 conectores. Colores: Gris, azul, rojo y amarillo. Impresión: Serigrafía o tampografía.



NUEVO





HIELETRAS

Hielera Doble

Hielera fabricada en nylon con 2 compartimentos para frío y calor.
Colores: Naranja, azul, rojo y blanco.
Impresión: Serigrafía.



TX-16

Hielera Cool Thai

Hielera fabricada en nylon con asa.
Colores: Naranja, azul, verde aqua y amarillo.
Impresión: Serigrafía.

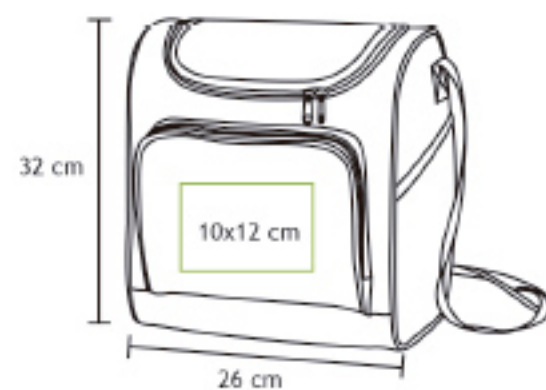

Hielera 6 Pack

Hielera térmica con asa y bolsa al frente
fabricada en nylon.

Colores: Negro, azul, rojo, naranja y amarillo.

Impresión: Serigrafía.

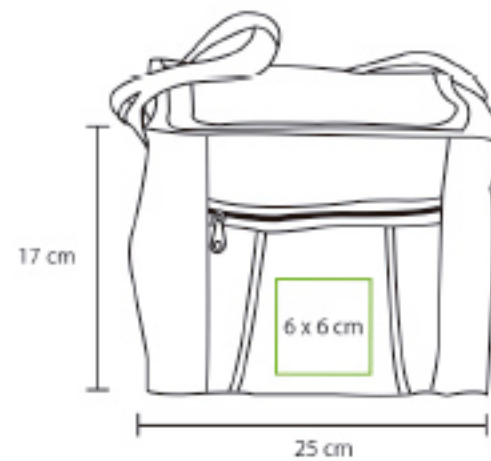

TX-21

Hielera 12 Pack

Hielera térmica con asa fabricada en nylon.

Colores: Naranja, azul, rojo y negro.

Impresión: Serigrafía.





TX-22

Hielera Boston

Hielera térmica con asa y bolsas al frente
fabricada en poliéster.

Colores: Azul, rojo, naranja y blanco.

Impresión: Serigrafía.



TX-37

Hielera Niza

Hielera térmica con forro PEVA
fabricada en Non-woven.

Colores: Naranja, azul, rojo y verde.
Impresión: Serigrafía.



TX-38

Hielera Cannes

Hielera térmica con asa y forro de PEVA
fabricada en poliéster 600D.
Colores: Verde y café.
Impresión: Serigrafía.



HM-06

Lunch to Go

Hielera rígida con 2 contenedores para
alimentos y cubiertos.

Colores: Azul y rojo.

Impresión: Serigrafía o tampografía.

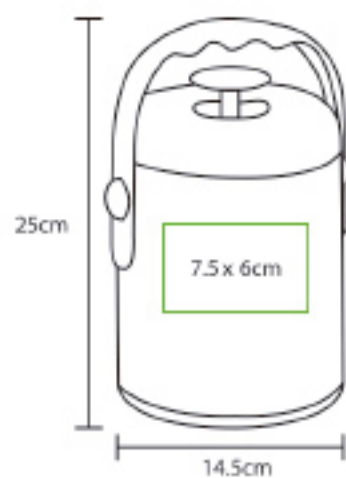



VIAJE

EX-06

Porta Documentos

Porta documentos para viaje con compartimento para pasaporte y porta pluma, fabricado en curpiel.

No incluye bolígrafo.

Impresión: Serigrafía o grabado láser.

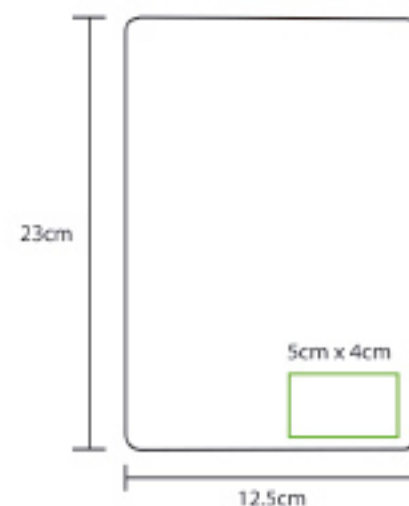

EX-11

Kit de Lustrado

Estuche cilíndrico fabricado en curpiel con accesorios para lustrado de calzado.

Impresión: Tampografía o grabado láser.

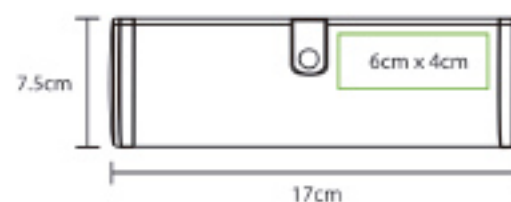

EX-16

Identificador Praha

Identificador para maletas metálico con broche de seguridad. Impresión: Serigrafía o grabado láser.



EX-29

Identificador Berna

Identificador de maletas y set de costura fabricado en plástico translúcido.

Colores: Azul, rojo y blanco.

Impresión: Serigrafía o tampografía.

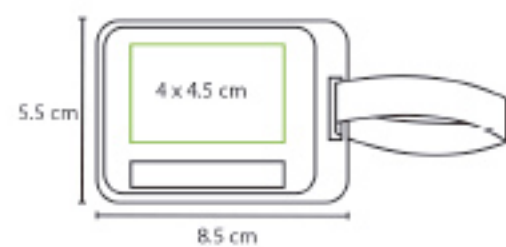



EX-30

Set 5 Piezas

Set de lustrado con 5 piezas en estuche metálico.
Impresión: Serigrafía, tampografía o grabado láser.

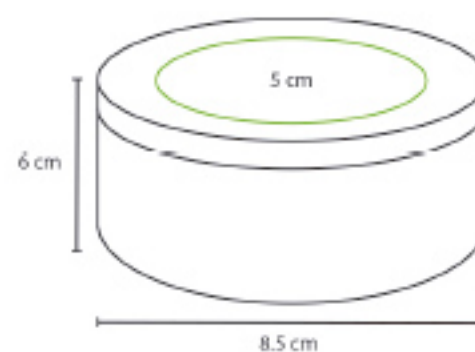

EX-31

Identificador Lublin

Identificador de maletas con sujetador,
fabricado en plástico.

Colores: Rosa, rojo, azul, morado, verde y naranja.
Impresión: Serigrafía o tampografía.



TX-39 ■■ ANTONIO MIRO ■■

Necesar

Necesar de nylon en color negro con compartimentos interiores.
Impresión: Serigrafía.

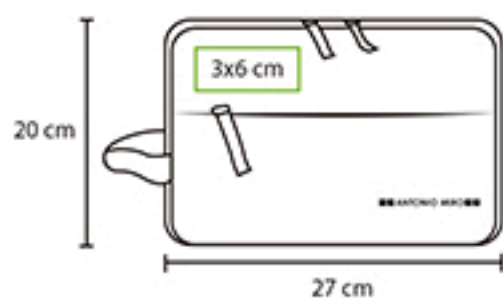

NUEVO

TX-07

Travel Bag

Bolsa multiusos desplegable con compartimentos y gancho.
Impresión: Serigrafía.

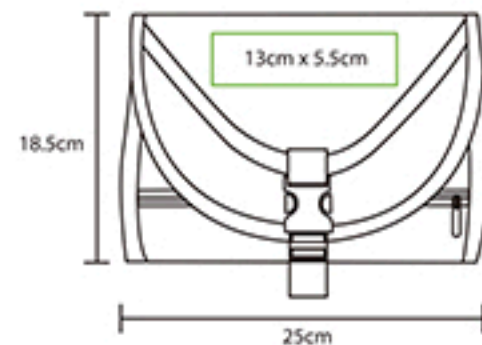

TX-09

Travel Bag

Bolsa multiusos que incluye kit de manicure, de lustrado y de costura.
Impresión: Serigrafía.

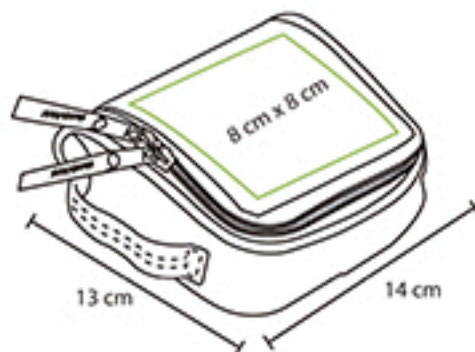

Carry-on EX-01

Porta Laptop

Portafolio para laptop con ruedas, mango retráctil de aluminio y amplios compartimentos interiores.

Incluye placa de aluminio
Impresión: Grabado láser.

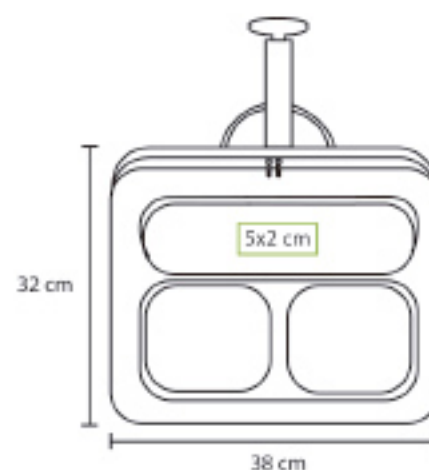

TX-15 Carry-on

Maleta de Viaje

Maleta con mango retráctil de aluminio, ruedas y bolsas laterales, fabricada en nylon.

Incluye placa de aluminio.
Impresión: Grabado láser.



Carry-on TX-29

Maleta Cracovia

Maleta porta trajes con ruedas, mango retráctil de aluminio y bolsa frontal, fabricada en poliéster. Incluye gancho y placa de aluminio. Impresión: Grabado láser.



TX-30 Carry-on

Maleta Burdeos

Maleta con ruedas, mango retráctil de aluminio y amplios compartimentos interiores, fabricada en poliéster. Impresión: Serigrafía.



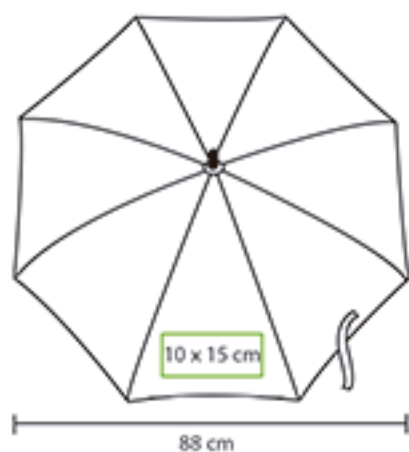

TX-08

Paraguas

Paraguas de bolsillo en poliéster con mango retráctil y funda.
Colores: Azul, negro y rojo.
Impresión: Serigrafía.



TX-40 ■■ ANTONIO MIRO ■■

Paraguas

Paraguas pongee automático con sistema anti viento, color negro.
Impresión: Serigrafía.

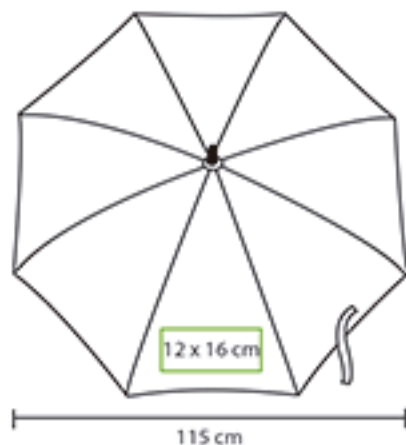

TX-31

Paraguas Bi-tono

Paraguas con 8 varillas de fibra de vidrio y poste de acero, fabricado en poliéster.

Colores: Naranja, rojo, azul y negro.
Impresión: Serigrafía.

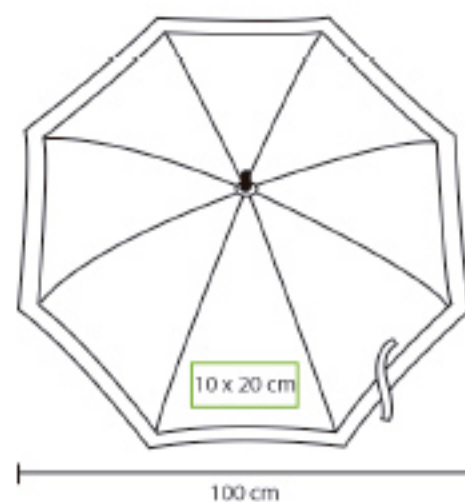

Carry-on TX-32

Maleta Nao

Trolley semirigido apto para cabina.
Colores: Azul, naranja y rojo.
Impresión: Serigrafía.



TX-33

Sombrero Caribbean

Sombrero para playa plegable.
Colores: Azul, naranja, negro y rojo.
Impresión: Serigrafía.



NUEVO



TX-34

Bolsa Maxi

Bolsa de playa fabricada en poliéster 600D.

Incluye neceser.

Colores: Rojo, azul, rosa, naranja y verde.

Impresión: Serigrafía.

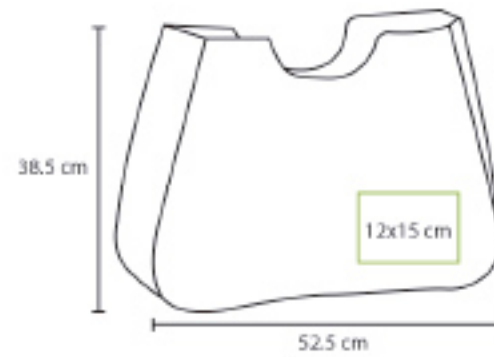



TX-36

Silla Mediterráneo

Silla plegable y ligera fabricada en poliéster.

Colores: Azul, naranja, azul cielo y rojo.

Impresión: Serigrafía.

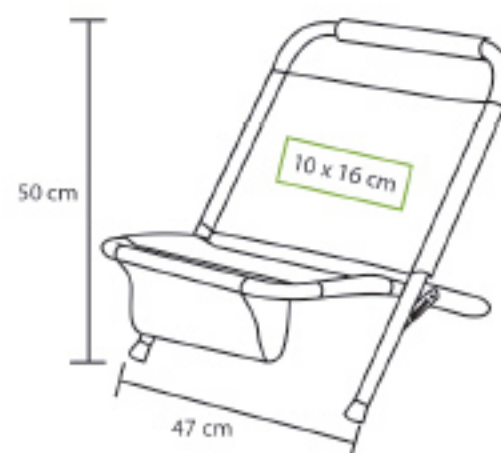

Requerimientos para Impresión, Grabado y Bordado

Métodos de Impresión, Grabado y Bordado

Método	Requerimientos
Impresión en Serigrafía Impresión en Tampografía Grabado Laser Grabado punta Diamante	Arte en vectores y tipografía en curvas compatibles con formatos .eps, .ai, .cdr y .pdf. sin contornos, porcentajes ni gradaciones de color. Con especificación de colores Pantone o Guía de Color.
Impresión en Digital	Arte en alta resolución (300 dpi) en formatos .jpg, .tiff, .psd y .pdf.
Bordado	Arte en vectores y tipografía en curvas compatibles con formatos .eps, .ai y .cdr si es .jpg en alta resolución (300 dpi) con especificación de colores Pantone o Guía de Color.

Diferencia entre mapa de bits y vectores

Un arte basado en vectores (formatos .eps, .ai y .cdr) es independiente de la resolución y se puede escalar a cualquier tamaño sin pérdida de detalle



Degradados

Los degradados solo se reproducen en la impresión digital no se reproducen en impresión con serigrafía y tampografía al igual que en los bordados o grabados por lo que el arte deberá estar en separación de colores sólidos.

ARTE PARA SALIDAS A IMPRESIÓN Y GRABADO



Colores Estandar

Muestra	Nombre	Código PANTONE
	Process Cyan C	
	Process Magenta C	
	Process Yellow C	
	Orange	PMS 021 C
	Red	PMS 032 C
	Burgundy	PMS 202 C
	Reflex Blue C	
	Navy Blue	PMS 281 C
	Purple	PMS 266 C
	Dark Green	PMS 342 C
	Brown	PMS 478 C
	Dark Gray	PMS 431 C
	Metallic Gold	PMS 871 C
	Metallic Silver	PMS 877 C

Los colores mostrados en esta página y en este catalogo no han sido evaluados por PANTONE Inc. para su precisión y pueden no coincidir con los colores estándar de PANTONE Inc. PANTONE es propiedad de PANTONE Inc.



Tipografías

Aceptamos cualquier tipo fuentes básicas o personalizadas, estas deberán estar convertidas en curvas o trazos compatibles con formatos .eps, .ai, .cdr y .pdf.

Arial	1234567890
Book Antigua	1234567890
Century	1234567890
Eras Demi ITC	1234567890
Franklin Gothic Book	1234567890
Futura Md BT	1234567890
Helvetica	1234567890
Optima	1234567890
<i>Finakti</i>	1234567890

TÉCNICAS DE IMPRESIÓN

Tu logotipo impreso con la **mejor técnica.**



GRABADO LÁSER

El aparato láser utiliza la energía del rayo láser para evaporar y por ende, quitar parte del material del que consiste la pieza a trabajar (madera, curpiel o metal) que ha sido colocada sobre la superficie de trabajo para ser sometida a los procesos de grabado raster, corte vector o el marcado vector. Esta técnica ofrece un acabado elegante, de calidad y permanente en los artículos donde se aplica.



TAMPOGRAFÍA

Consiste en una placa metálica o plástica, revestida de una emulsión fotosensible, donde se graba la imagen por un proceso químico, formando un huecograbado, esta placa es cubierta de tinta y barrida por una cuchilla, posteriormente un tampón de silicona presiona sobre el grabado de la placa recogiendo la tinta del huecograbado y transportándola sobre la pieza que será impresa por contacto. Esta técnica es recomendada en artículos curvos o irregulares.



SERIGRAFÍA

Técnica de impresión que consiste en transferir una tinta a través de una malla tensada en un marco, el paso de la tinta se bloquea en las áreas donde no habrá imagen mediante una emulsión o barniz, quedando libre la zona donde pasará la tinta. El sistema de impresión es repetitivo, esto es, una vez que el primer modelo se ha logrado, la impresión puede ser repetida cientos y hasta miles de veces sin perder definición.



TRANSFER DIGITAL

Por medio de esta técnica podemos imprimir imágenes o logos (que puede ser multicolor) mediante una plancha de calor que entra en contacto con una hoja de papel adecuada que tiene impresa y adherida la imagen que a su vez se adhiere en la superficie del producto. Esta técnica puede adaptarse a productos textiles como son, mochilas, maletas, hieleras, bolsas, etc., siempre y cuando el material del producto lo permita.

TÉCNICAS DE IMPRESIÓN

Tu logotipo impreso con la **mejor técnica.**

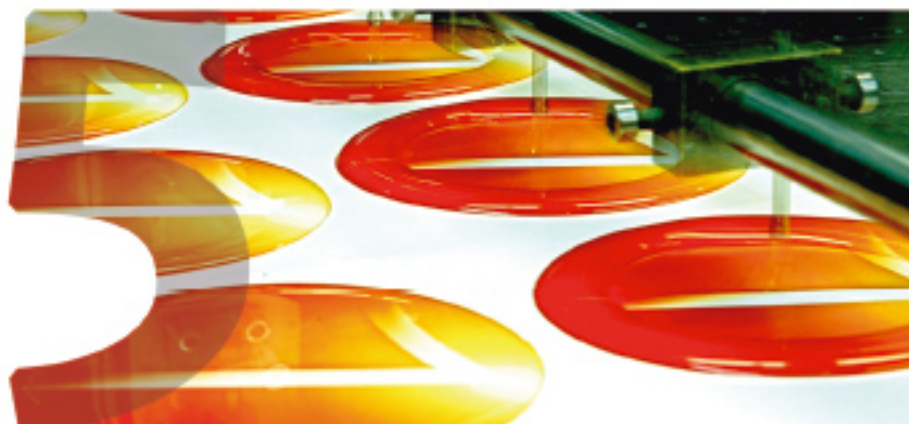

GOTA DE RESINA

Esta técnica es una combinación de una etiqueta impresa en un adhesivo (que puede ser multicolor) al que se aplica posteriormente una gota de resina de poliuretano totalmente transparente para producir un efecto lupa con el fin de resaltar los autoadhesivos. El adhesivo se pega posteriormente al artículo de consistencia semirrígida, resiste los golpes y las roturas. Gracias a su elasticidad, permite colocar los adhesivos sobre superficies ligeramente curvadas.



BORDADO

El bordado es una técnica que se realiza sobre tela, mediante la acción de la aguja y el empleo de hilos. Actualmente, máquinas especiales realizan este tipo de bordados aplicándose sobre cualquier tipo de prendas y géneros textiles. Es posible bordar logos en gorras, camisetas, ropa de trabajo y en todos aquellos elementos que en su confección cuenten con tela.



IMPRESIÓN DIGITAL





















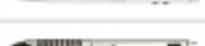









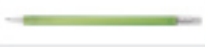



Técnica de impresión por inyección, para productos planos y en 3D, se puede aplicar casi en cualquier material. Se marca el logotipo o imagen directamente en el producto utilizando la técnica de impresión digital y obteniendo una calidad extrema. Con esta técnica el diseño se marca en cuatricromía y los detalles pueden estar mejor definidos. El marcaje es de gran precisión y es posible marcar varios colores o un simple texto.

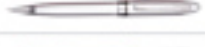

















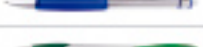























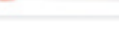





























SUBLIMACIÓN





































La sublimación es la técnica para el marcaje de objetos mediante transferencia de la tinta al objeto con la aplicación de calor. La sublimación permite transferir imágenes y diseños a gran variedad de objetos como jarras, platos, tazas, etc. Estos objetos tienen que estar recubiertos de un barniz de poliéster.

INDICE POR CLAVE

























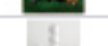









CLAVE	PAGINA	PRODUCTO	EMPAQUE(CAJA)		
			MEDIDA	PIEZAS	PESO
BE - 01	18		38X31X32	200	8 kg
BE - 02	18		43X29X41	400	14.5 kg
BE - 03	19		50X32X44	500	12 kg
BE - 04	19		55X31X43	500	11 kg
BE - 05	20		53X25X30	200	8 kg
BE - 06	20		43X27X15	500	11 kg
BE - 07	21		37X28X52	200	14.5 kg
BE - 08	21		30X29X30	200	8 kg
BE - 09	21		48X23X30	200	12.5 kg
BE - 10	23		28X25X32	1,000	12 kg
BE - 11	23		45X40X15	400	14 kg
BL - 01	74		44X37X23	100	11.57 kg
BL - 02	74		34X27X29	200	11.18 kg
BL - 03	75		44X41X25	200	10.50 kg
BL - 05	75		35X25X15	500	13.00 kg
BL - 07	76		37X29X24	100	8.76 kg
BL - 08	76		42X24X37	200	10.18 kg
BL - 09	77		48X27X19	500	9.96 kg
BL - 10	77		45X24X33	200	10.88 kg
BL - 11	78		35X26X26	200	14.34 kg
BL - 12	78		36X26X26	200	10.16 kg
BL - 17	79		53X31X22	1,000	12.32 kg
BL - 18	79		48X30X20	1,000	11.57 kg
BL - 19	80		44X37X23	1,000	12.25 kg
BL - 20	80		39X33X31	100	13.00 kg
BL - 21	81		43X31X20	1,000	12.50 kg
BL - 22	81		43X31X18	1,000	12.32 kg
BL - 23	82		48X31X22	1,000	12.48 kg
BL - 24	82		48X31X20	1,000	12.40 kg
BL - 25	83		50X31X22	1,000	13.00 kg
BL - 26	83		45X30X18	1,000	12.50 kg
BL - 27	84		41X31X20	1,000	12.30 kg
BL - 28	84		48X31X20	1,000	12.43 kg
BL - 29	85		50X34X24	1,000	12.40 kg
BL - 30	85		45X30X18	1,000	12.42 kg
BL - 31	86		58X31X22	1,000	12 kg





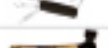































CLAVE	PAGINA	PRODUCTO	EMPAQUE(CAJA)		
			MEDIDA	PIEZAS	PESO
BL - 33	86		52X31X22	1,000	9 kg
BL - 34	87		50X31X22	1,000	11.5 kg
BL - 35	87		51X30X23	1,000	10 kg
BL - 36	88		53X31X20	1,000	10 kg
BL - 37	88		53X31X21	1,000	10.5 kg
BL - 38	89		48X31X20	1,000	8 kg
BL - 39	89		48X31X20	1,000	9 kg
BL - 40	90		51X31X20	1,000	11 kg
BL - 41	90		55X31X20	1,000	12 kg
BL - 42	91		48X31X20	1,000	11 kg
BL - 43	91		53X31X22	1,000	12 kg
BL - 44	92		43X30X20	1,000	8 kg
BL - 45	92		51X30X20	1,000	9 kg
BL - 46	93		43X29X19	1,000	7 kg
BL - 47	93		45X31X19	1,000	8 kg
BL - 48	94		50X31X22	1,000	11.5 kg
BL - 49	94		45X31X19	1,000	7 kg
BL - 50	95		48X30X20	1,000	10 kg
BL - 51	95		43X31X20	1,000	9 kg
BL - 52	96		42X31X18	1,000	7 kg
BL - 53	96		68X31X22	500	11.5 kg
BL - 54	97		68X31X20	1,000	13 kg
BL - 55	97		55X31X23	1,000	11 kg
BL - 56	98		45X28X22	1,000	7.5 kg
BL - 57	98		45X31X19	1,000	8 kg
BL - 58	99		50X33X22	1,000	7.5 kg
BL - 59	99		50X35X20	1,000	7 kg
BL - 60	100		50X31X20	1,000	13 kg
BL - 61	100		48X31X20	1,000	9 kg
BL - 62	101		55X30X22	1,000	13 kg
BL - 63	101		48X31X20	1,000	9 kg
BL - 65	102		45X30X18	1,000	7 kg
BL - 66	102		48X30X20	1,000	11 kg
BL - 67	103		50X31X20	1,000	12 kg
BL - 68	107		42X30X16	200	13 kg
BL - 69	103		43X31X24	2000	12 kg





































CLAVE	PAGINA	PRODUCTO	EMPAQUE(CAJA)		
			MEDIDA	PIEZAS	PESO
BL - 70	104		52X31X20	1,000	12 kg
BL - 71	104		72X34X30	200	22 kg
BL - 72	105		48X34X22	200	5 kg
BL - 73	105		50X31X20	1,000	9 kg
BL - 74	106		50X31X22	1,000	13 kg
BL - 75	106		68X31X20	400	15 kg
BL - 76	106		57X37X29	200	15.5 kg
DK - 05	188		43X26X38	20	13 kg
DK - 13	188		46X37X17	50	8.74 kg
DK - 15	230		49X22X32	50	12.32 kg
DK - 16	230		37X22X24	50	16.78 kg
DK - 17	231		37X22X24	50	16.16 kg
DK - 20	189		30X27X21	60	8.6 kg
DK - 21	189		44X39X43	50	10.5 kg
DK - 22	190		64X40X27	48	19.40 kg
DK - 23	190		64X40X27	40	16.00 kg
DK - 24	68		66X45X23	72	15.70 kg
DK - 26	191		29X23X29	300	15.40 kg
DK - 27	191		29X23X29	300	17.40 kg
DK - 28	192		29X23X29	300	17.50 kg
DK - 29	192		31X29X29	500	17.60 kg
DK - 30	192		60X28X27	240	9.00 kg
DK - 31	191		47X36X60	40	15.70 kg
DK - 32	193		24X18X25	200	5.12 kg
DK - 33	107		46X20X27	100	9.94 kg
DK - 34	193		42X36X49	20	12.00 kg
DK - 35	194		34X29X28	36	13.50 kg
DK - 36	194		36X41X42	160	11.50 kg
DK - 37	195		49X42X38	40	13.50 kg
DK - 38	195		58X28X27	100	14.50 kg
DK - 39	108		59X40X24	200	12.69 kg
DK - 40	108		53X37X38	500	12.50 kg
DK - 41	28		53X37X38	500	12.50 kg
DK - 42	196		47X38X44	50	11 kg
DK - 43	196		27X26X30	24	13 kg
DK - 44	109		38X32X36	400	8 kg





































CLAVE	PAGINA	PRODUCTO	EMPAQUE(CAJA)		
			MEDIDA	PIEZAS	PESO
DK - 45	109		45X32X30	480	14.5 kg
DK - 46	28		41X35X20	400	10 kg
DK - 47	29		54X36X23	72	11 kg
DK - 48	29		36X32X28	100	10 kg
DK - 49	30		45X25X22	100	8 kg
DK - 50	30		36X36X21	192	18 kg
DK - 52	197		47X30X17	500	6 kg
DK - 55	55		44X30X30	200	15.5 kg
DK - 56	199		34X30X26	200	7 kg
DK - 57	200		54X34X30	500	12 kg
DK - 58	198		46X17X35	250	16 kg
DK - 59	197		57X31X16	50	7.5 kg
DK - 60	198		33X28X25	40	13 kg
DK - 61	201		50X30X31	250	12.5 kg
DK - 62	199		52X30X42	100	12.5 kg
DK - 63	202		40X28X29	1,000	13.5 kg
EX - 01	286		46X45X38	2	24.70 kg
EX - 05	38		50X28X34	15	13.96 kg
EX - 06	282		54X33X33	40	12.60 kg
EX - 08	39		49X37X29	200	12.50 kg
EX - 09	39		66X45X24	440	13.20 kg
EX - 10	40		49X33X29	200	11.04 kg
EX - 11	282		52X26X41	36	12.78 kg
EX - 12	40		59X24X35	500	27.02 kg
EX - 13	112		36X23X37	100	16.38 kg
EX - 14	112		37X21X35	100	17.44 kg
EX - 15	201		46X30X26	1,000	11.50 kg
EX - 16	283		37X30X25	500	11.28 kg
EX - 18	41		45X42X27	200	12.30 kg
EX - 19	41		49X33X29	200	13.10 kg
EX - 20	42		69X36X25	100	9.60 kg
EX - 21	42		54X34X35	20	20.62 kg
EX - 22	43		59X40X27	30	15.36 kg
EX - 23	43		48X33X51	200	14.50 kg
EX - 24	44		48X26X35	25	15.60 kg
EX - 25	45		51X36X34	25	15.30 kg

INDICE POR CLAVE

































CLAVE	PAGINA	PRODUCTO	EMPAQUE(CAJA)		
			MEDIDA	PIEZAS	PESO
EX - 28	39		55X31X25	500	9.5 kg
EX - 29	283		38X36X20	250	7 kg
EX - 30	284		56X43X33	100	15 kg
EX - 31	284		35X26X40	500	9 kg
EX - 32	46		47X42X28	40	14 kg
EX - 33	47		66X29X38	20	16 kg
EX - 34	47		52X27X35	20	14.5 kg
EX - 35	48		45X45X35	20	18 kg
EX - 36	48		70X35X40	20	12 kg
EX - 37	49		52X31X45	10	10 kg
EX - 38	49		62X35X40	40	14 kg
EX - 39	50		40X32X60	40	13 kg
EX - 40	50		00X00X00	00	00 kg
GL - 02	202		42X36X62	50	17.9 kg
GL - 04	236		38X35X33	12	19.75 kg
GL - 07	236		48X41X28	250	16.72 kg
GL - 08	237		46X46X16	100	15.02 kg
HE - 01	113		40X24X29	40	12.66 kg
HE - 02	113		45X22X32	50	7.88 kg
HE - 03	114		35X27X27	100	9.98 kg
HE - 04	114		31X28X22	100	13 kg
HE - 05	115		45X40X18	60	15.5 kg
HE - 06	237		62X32X22	50	16.2 kg
HE - 07	116		40X46X22	60	15 kg
HE - 08	116		49X26X38	48	17.5 kg
HE - 09	115		61X46X26	12	15.1 kg
HE - 10	117		41X32X36	500	12.5 kg
HE - 11	117		27X24X32	400	11 kg
HE - 12	118		53X38X18	500	10.5 kg
HE - 13	118		37X32X26	200	12.5 kg
HE - 14	119		36X25X23	200	15 kg
HE - 15	119		30X28X27	300	15 kg
HE - 16	120		43X21X41	100	13 kg
HE - 17	120		34X20X25	300	8.5 kg
HE - 18	121		28X25X22	36	13 kg
HE - 19	121		38X36X35	60	15.5 kg

CLAVE	PAGINA	PRODUCTO	EMPAQUE(CAJA)		
			MEDIDA	PIEZAS	PESO
HE - 20	122		24X20X20	60	15.5 kg
HE - 21	122		30X20X24	100	7 kg
HE - 23	123		44X40X23	200	15.5 kg
HE - 24	124		46X23X29	100	8.5 kg
HE - 25	123		43X29X29	20	11 kg
HM - 04	126		65X44X40	48	10.7 kg
HM - 06	280		64X49X55	24	13.61 kg
HM - 07	12		50X34X31	24	15.1 kg
HM - 08	12		35X35X32	24	12.06 kg
HM - 09	126		61X46X26	12	15.1 kg
HM - 10	127		32X29X32	6	7.46 kg
HM - 11	13		41X41X52	24	11.5 kg
HM - 12	56		62X62X35	24	16.5 kg
HM - 13	13		53X23X23	1,000	13.5 kg
HM - 14	127		58X43X50	400	12.5 kg
HM - 16	14		48X30X22	500	12.5 kg
HM - 17	14		61X25X38	10	9 kg
HM - 18	128		40X40X31	12	14 kg
HM - 19	129		68X35X45	20	10 kg
HM - 20	128		38X27X29	10	9.5 kg
HM - 21	15		45X40X39	6	10 kg
HM - 22	16		26X26X31	6	10 kg
HM - 23	16		40X27X37	24	10.5 kg
I - 01	232		50X50X32	100	15.16 kg
I - 03	232		36X17X49	100	15.16 kg
I - 04	232		33X31X34	100	8.50 kg
I - 05	232		49X48X40	100	15.14 kg
KD - 02	66		53X53X20	100	13 kg
KD - 03	66		53X53X20	100	13 kg
KD - 04	66		53X53X20	100	13 kg
KD - 06	67		59X47X43	100	11 kg
KD - 07	55		53X49X26	100	13 kg
KD - 08	56		59X50X66	60	13 kg
KD - 09	67		52X45X38	600	13 kg
KD - 10	64		36X24X32	600	13 kg
LB - 01	132		41X33X23	80	11.68 kg

CLAVE	PAGINA	PRODUCTO	EMPAQUE(CAJA)		
			MEDIDA	PIEZAS	PESO
LB - 02	133		40X30X30	100	11.56 kg
LB - 03	134		40X32X32	200	12.3 kg
LB - 04	135		40X30X20	36	10.5 kg
LB - 05	136		40X32X20	100	11.12 kg
LB - 06	137		36X22X25	50	11.5 kg
LB - 07	138		41X24X28	50	11.2 kg
LB - 08	139		37X24X30	100	10 kg
LB - 09	139		46X27X23	300	13 kg
LB - 10	140		44X49X45	300	12.5 kg
LB - 11	141		43X35X33	100	12.5 kg
LB - 12	142		37X23X49	160	13 kg
LB - 13	143		85X18X17	50	8 kg
LB - 14	144		30X26X28	100	8 kg
LB - 15	144		55X39X34	500	23.5 kg
LB - 16	145		43X26X26	200	17 kg
LB - 17	145		34X34X31	100	10.5 kg
LB - 18	146		36X30X24	200	15.5 kg
LL - 01	148		46X35X34	250	18.76 kg
LL - 02	148		47X35X36	250	17.5 kg
LL - 03	148		48X35X30	500	16.14 kg
LL - 04	149		39X31X29	250	10.62 kg
LL - 05	149		63X29X32	250	11.23 kg
LL - 06	149		48X35X30	500	17.7 kg
LL - 07	150		48X35X30	500	16.58 kg
LL - 08	150		39X31X29	250	12.64 kg
LL - 09	150		62X26X34	250	15.34 kg
LL - 10	151		42X30X28	200	9.08 kg
LL - 11	151		61X37X31	600	31.06 kg
LL - 12	152		42X33X29	2,000	20.74 kg
LL - 13	152		39X24X34	250	10.28 kg
LL - 14	153		39X24X34	250	8.68 kg
LL - 15	153		39X31X29	250	9.67 kg
LL - 16	154		39X35X30	300	10.5 kg
LL - 17	154		39X35X30	300	10.5 kg
LL - 18	154		42X30X37	300	10.5 kg
LL - 19	155		39X35X30	300	10.5 kg



























CLAVE	PAGINA	PRODUCTO	EMPAQUE(CAJA)		
			MEDIDA	PIEZAS	PESO
LL - 20	155		57X20X16	500	12 kg
LL - 21	156		36X21X21	500	15 kg
LL - 22	156		33X18X18	500	10 kg
LL - 23	156		48X29X32	500	14 kg
LL - 24	157		28X27X40	1,000	11.5 kg
LL - 25	157		33X18X18	500	10 kg
LL - 26	158		44X19X20	200	4.5 kg
LL - 27	159		41X28X25	1,000	10 kg
LL - 28	159		39X32X29	300	10.5 kg
MP - 02	167		39X32X29	300	10.5 kg
PD - 01	228		53X32X33	10	8.22 kg
PD - 02	229		47X27X28	10	5.52 kg
PD - 03	228		47X37X37	10	8.88 kg
PD - 04	230		54X32X33	10	9.6 kg
RK - 04	206		60X32X40	120	5.50 kg
RK - 05	207		45X29X40	100	5.37 kg
RK - 07	206		46X32X26	250	5.70 kg
RK - 09	208		60X32X40	400	6.10 kg
RK - 11	208		45X34X43	250	5.32 kg
RK - 12	209		46X34X41	100	9 kg
RK - 13	209		46X34X41	100	13.5 kg
RP - 01	210		44X28X24	250	5.52 kg
RP - 02	210		44X28X24	250	6.70 kg
RP - 03	211		39X27X27	250	5.78 kg
RP - 04	211		46X32X24	250	5.41 kg
RP - 05	212		39X27X27	250	6.10 kg
RP - 06	212		46X32X24	250	6.21 kg
RP - 07	213		39X27X27	250	5.41 kg
RP - 08	213		40X30X31	200	5.62 kg
RP - 09	213		39X27X27	250	5.78 kg
RP - 10	214		41X30X32	200	5.84 kg
RP - 11	214		40X40X37	250	5.41 kg
RP - 12	214		40X40X37	250	5.98 kg
RP - 13	215		41X30X32	100	5.12 kg
RP - 14	215		40X30X37	250	5.21 kg
RP - 15	215		40X40X37	250	5.19 kg

INDICE POR CLAVE

CLAVE	PAGINA	PRODUCTO	EMPAQUE(CAJA)		
			MEDIDA	PIEZAS	PESO
RP - 16	216		41X30X32	200	5.36 kg
RP - 18	216		48X32X26	250	5.81 kg
RP - 19	216		41X30X32	100	5.64 kg
RP - 21	217		46X32X24	250	5.73 kg
RP - 22	217		39X27X27	250	5.84 kg
RP - 23	218		46X32X24	250	5.15 kg
RP - 24	218		46X32X25	250	5.73 kg
RP - 25	219		46X32X24	250	5.42 kg
RP - 26	220		39X27X27	200	5.16 kg
RP - 27	221		50X30X27	200	5.55 kg
RP - 28	219		42X27X27	300	5.72 kg
RP - 29	222		38X28X28	50	11.20 kg
RP - 30	222		47X38X44	200	5.46 kg
RP - 33	223		47X38X44	50	11.20 kg
RP - 36	223		40X30X30	200	5.66 kg
RP - 37	224		41X30X32	150	5.66 kg
RP - 38	223		41X30X30	100	5.72 kg
RP - 39	224		45X35X48	500	5.66 kg
RP - 40	225		41X30X32	200	5.98 kg
RP - 41	225		44X28X24	200	5.69 kg
RP - 42	226		41X30X32	150	6.71 kg
RP - 43	226		38X32X35	200	5.10 kg
RP - 44	227		42X30X40	200	13 kg
SB - 01	4		69X35X35	250	6 kg
SB - 02	4		44X39X45	288	9 kg
SB - 03	4		69X35X35	250	6 kg
SB - 04	5		69X35X35	250	6 kg
SB - 05	5		69X35X35	250	6 kg
SB - 06	5		38X38X62	250	5.5 kg
SB - 07	6		51X26X27	250	6 kg
SB - 08	6		38X34X21	100	5 kg
SB - 09	7		51X36X47	250	8.5 kg
SB - 10	7		70X40X29	250	9 kg
SB - 11	8		67X41X36	300	6 kg
SB - 12	8		62X46X36	250	10 kg
SB - 13	9		74X41X32	200	6.5 kg

CLAVE	PAGINA	PRODUCTO	EMPAQUE(CAJA)		
			MEDIDA	PIEZAS	PESO
SB - 14	9		54X40X21	250	5.5 kg
SB - 15	10		50X46X26	250	7 kg
SB - 16	10		48X41X41	250	6.5 kg
SB - 17	10		47X45X36	250	9.5 kg
SP - 01	238		46X36X23	500	8 kg
ST - 01	203		51X37X30	10	19.28 kg
ST - 02	227		55X35X35	50	14.54 kg
ST - 05	51		44X25X42	40	13.28 kg
ST - 06	51		51X38X24	100	9.34 kg
ST - 10	22		27X26X26	48	15.50 kg
ST - 11	22		44X34X35	144	10.00 kg
ST - 12	204		40X27X37	30	14.7 kg
TE - 01	240		41X33X28	20	9.14 kg
TE - 02	241		56X40X58	48	15.87 kg
TE - 03	242		50X50X20	20	6.72 kg
TE - 06	241		57X39X26	24	14.63 kg
TE - 07	243		79X48X28	60	14.40 kg
TE - 08	243		57X39X26	24	13.75 kg
TE - 10	244		48X40X40	60	12.46 kg
TE - 11	245		46X31X52	48	12.54 kg
TE - 12	246		45X45X47	50	13.74 kg
TE - 13	246		51X43X59	60	13.74 kg
TE - 14	247		47X47X57	72	13.5 kg
TE - 15	247		51X51X42	24	14.2 kg
TE - 16	248		44X30X48	48	6 kg
TE - 17	249		47X32X55	48	6 kg
TE - 18	249		48X42X39	48	9.5 kg
TE - 19	250		40X40X38	50	7.5 kg
TE - 20	251		46X38X52	60	6 kg
TE - 21	252		79X44X26	48	13 kg
TE - 22	253		59X48X28	48	11 kg
TE - 23	254		50X29X23	24	5 kg
TE - 24	254		56X51X39	48	12 kg
TE - 25	255		59X44X27	48	8 kg
TE - 26	256		59X45X30	48	8 kg
TE - 27	257		48X32X25	24	5 kg

CLAVE	PAGINA	PRODUCTO	EMPAQUE(CAJA)		
			MEDIDA	PIEZAS	PESO
TE - 28	258		64X43X21	24	6 kg
TE - 29	259		38X37X22	25	6.5 kg
TH - 01	262		52X49X39	300	10.74 kg
TH - 02	262		41X32X27	100	8.76 kg
TH - 07	263		40X23X39	60	11.36 kg
TH - 09	263		52X52X65	500	6.85 kg
TH - 11	264		42X38X20	250	11.25 kg
TH - 13	264		47X38X32	350	8.96 kg
TH - 15	265		54X36X42	40	11.25 kg
TH - 17	266		53X33X38	80	19.14 kg
TH - 19	265		47X32X35	550	19 kg
TH - 20	266		42X33X21	800	6 kg
TH - 21	267		55X36X30	500	18.5 kg
TH - 22	267		44X38X36	240	13 kg
TH - 24	268		40X26X37	10	9.5 kg
TH - 25	269		52X40X33	20	10 kg
TH - 23	269		55X40X26	1,000	16 kg
TH - 26	270		50X35X38	100	10.5 kg
TH - 27	271		50X25X50	80	10 kg
TX - 01	176		40X30X30	15	11.30 kg
TX - 02	177		45X34X46	20	17.48 kg
TX - 07	285		38X26X46	50	11.70 kg
TX - 08	288		25X25X46	60	16.74 kg
TX - 09	285		40X34X47	36	22.71 kg
TX - 10	178		45X33X41	20	12.74 kg
TX - 11	274		49X42X45	40	13.38 kg

CLAVE	PAGINA	PRODUCTO	EMPAQUE(CAJA)		
			MEDIDA	PIEZAS	PESO
TX - 12	179		53X33X36	20	17.54 kg
TX - 13	181		49X38X37	24	9.66 kg
TX - 14	182		50X30X50	24	12.02 kg
TX - 15	286		60X36X54	42	8.73 kg
TX - 16	275		37X30X65	24	12.5 kg
TX - 17	180		62X41X52	15	13.14 kg
TX - 18	180		51X35X53	20	12.87 kg
TX - 19	61		45X40X25	200	12.3 kg
TX - 20	276		47X38X24	12	12 kg
TX - 21	277		61X27X38	24	14 kg
TX - 22	278		60X30X38	20	10 kg
TX - 23	183		43X32X31	20	9 kg
TX - 24	183		45X31X48	24	11 kg
TX - 25	184		49X35X37	24	16 kg
TX - 26	184		49X38X32	15	16 kg
TX - 27	185		42X42X35	30	8 kg
TX - 29	287		59X44X57	4	17 kg
TX - 30	287		59X38X45	4	17 kg
TX - 31	289		26X26X45	60	14.5 kg
TX - 32	290		55X42X38	2	5 kg
TX - 33	290		67X43X33	250	14 kg
TX - 34	291		52X41X21	30	14 kg
TX - 35	186		54X31X40	6	8.5 kg
TX - 36	292		77X48X22	6	13 kg
TX - 37	279		56X42X52	80	10 kg
TX - 38	280		60X34X37	10	8 kg



Los logotipos y marcas que se publican en este catálogo son con fines demostrativos e ilustrativos y no implican ningún tipo de licencia o distribución, la empresa no ha participado en sus diseños ni cuenta con ningún tipo de derechos de estas marcas, por lo que no están a la venta. Las medidas y áreas de impresión pueden variar de acuerdo al producto.

Los derechos son reservados por lo que queda prohibida la reproducción total o parcial por cualquier medio sin la autorización expresa de la empresa.

Diseño: D.G. Osvaldo Hernández
Fotografía: Adriana Garibay

Innovation Line y Bakio son marcas registradas.

